

Just Press "Print"

Canada's Additive Manufacturing Ecosystem

Research by



The Information and Communications
Technology Council

Canada 

This project is funded in part by the
Government of Canada's Sectoral
Initiatives program.

Preface

ICTC is a national centre of expertise on the digital economy. With over 25 years of experience in research and program development related to technology, ICTC has the vision of strengthening Canada's digital advantage in the global economy. Through forward-looking research, evidence-based policy advice, and creative capacity building programs, ICTC fosters innovative and globally competitive Canadian industries, empowered by a talented and diverse workforce.

To cite this report:

Herron, C.; Ivus, M.; Kotak, A. "Just Press 'Print': Canada's Additive Manufacturing Ecosystem," Information and Communications Technology Council (ICTC), March 2021, Ottawa, Canada.

Researched and written by Maryna Ivus (Manager, Labour Market Research), Akshay Kotak (Senior Economist and Research Analyst), Chris Herron (Junior Research Analyst) with generous support from Rob Davidson (Director, Data Analytics), Arun Sharvirala (Data Analyst), Amal Das (Junior Data Analyst), and the ICTC Digital Think Tank team.

The opinions and interpretations in this publication are those of the author and do not necessarily reflect those of the Government of Canada.

Abstract

The purpose of this report, *Just Press 'Print': Canada's Additive Manufacturing Ecosystem*, is to explore Additive Manufacturing (AM) technologies and their applications, strengths, weakness, and challenges; evaluate the state of Canada's AM ecosystem; assess the demand for AM talent; and propose recommendations for increasing the adoption of AM technologies across Canada. This study draws on primary and secondary research. Primary research included interviews with industry experts, input from an advisory committee, and web scraping for in-demand jobs and skills across Canada's AM ecosystem. Secondary research includes a review of academic and industry publications.

AM comprises a diverse, growing group of technologies, processes, and materials. Numerous uses cases exist for applying AM, ranging from rapid prototyping to mass customization and even some forms of mass manufacturing. Although AM is used for design and prototyping across the manufacturing industry, intensive research and adoption in AM is more limited.

Canada is a small player in the global AM ecosystem, with low levels of manufacturing output compared to industry giants such as the US and China. Nevertheless, it boasts several world-renowned firms that are either focused on developing AM-related technology, adopting it to production, or both. In several niche areas, it possesses strong vertical integration, high levels of research output, and strong relationships between academia and industry.

COVID-19 has disrupted manufacturing paradigms worldwide and has given AM an opportunity to demonstrate some of its strengths. However, it has also cast light on many of Canada's weaknesses in AM, such as weak supply chains, a fragmented ecosystem, and a risk-averse culture among investors and established manufacturers.

This report presents a case study on Germany, a recognized global leader in AM. The case study serves as a model of a successful ecosystem and provides a list of possible guiding actions for Canadian industry and government as they continue to establish a strong AM ecosystem.

Key Words:

Additive Manufacturing
Advanced technologies
Competitiveness Analysis
Workforce Development
Industry recommendations

3D printing
COVID-19 impacts
Labour Market Research
Pandemic impacts
Education

Application
Adoption
Policy
Canada

Acknowledgements

The contributions made to this report by our 26 Key Informant Interviewees and 25 Advisory Committee members are greatly appreciated. We would like to acknowledge all the participants in our study, including the following:

Bartosz Bos: Additive Manufacturing Consultant, Island Additive

Bell Textron Canada Ltd.

Cassidy Silbernagel, PhD: Senior Additive Manufacturing Mechanical Engineer, Exergy Solutions

Francesco Iorio, PhD: CEO, Augmenta AI

Farzaneh Farhang Mehr, PhD: Director of Additive Manufacturing, University of British Columbia

Floriane Zongo, PhD: Additive Manufacturing Consultant

Frank Defalco: Director, Member Relations, NGen

Gianni Panfili: Additive Manufacturing Manager, Siemens Energy

Hargurdeep (Deep) Singh: Vice-President, Additive Manufacturing, CAD MicroSolutions

Harold Godwin: Managing Director, Waterloo Advanced Manufacturing Consortium

Iee Lee Hia, PhD: Postdoctoral Fellow, Polytechnique Montreal

Jean-Pierre Giroux: President, Excellence in Manufacturing Consortium

John Manley: President, Machine Tool Systems

Jonathan Ladouceur: Head of Engineering, Twente Additive Manufacturing

Kanwal Chadha, PhD: Postdoctoral Researcher, University of New Brunswick

Kassim al-Rubaie, PhD: Research Fellow, McMaster University

Kevin Han: CEO, AON3D

Manuel Martin, PhD: Technical lead for Additive Manufacturing, National Research Council of Canada

Mathieu Brochu, PhD: Associate Professor, McGill University

Matthew Harding, PhD: Program Manager, Tronosjet

Maya HTT

Michael Barré: Industrial Technology Advisor, Industrial Research Assistance Program, National Research Council of Canada (IRAP-NRC)

Mostafa Yakout, PhD: Postdoctoral Fellow, McMaster University

Nejib Chekir, PhD: Additive Manufacturing Specialist, Liburdi Automation Inc.

Parker Drouillard: CEO, Pep Corp

Philippe Dupuis, PhD: Senior Engineering and Additive Project Manager, Precision ADM

Sofiane Benyouci: Partner, Vice-president Consulting, Innovitech

Stan Kleinikkink: Innovation Manager, ATS

Steph Sharp: CEO, 3DQue Systems Inc.

Stephan Mansour: Construction Digitization and Sector 3D Printing Specialist, Autodesk

Tonya Wolfe, PhD: Manager, Centre for Innovation in Manufacturing, Technology Access Centre, Red Deer College

Trevor Johnstone: Director of Additive Manufacturing, DesignFusion

Vesna Cota: Voting Member, Board of Directors, NSERC/CFI Strategic Network for Holistic Innovation in Additive Manufacturing

Zander Chamberlain: Director of Additive Manufacturing, 3D Additive Fabrication

Direct quotations of Key Informant Interviewees and Advisory Committee Members in this report have been anonymized to protect the identity of the speaker. Please note that not all study participants who contributed quotes consented to be named in the preceding "Acknowledgements" section, and not all participants named in the "Acknowledgements" section are directly quoted in the report.

Table of Contents

Glossary of Key Terms	9
List of Acronyms Used in this Report	13
Foreword	14
Executive Summary	15
Introduction and Background	17
What is Additive Manufacturing?	18
• Additive Manufacturing: A Brief History	19
• The Seven Families of Additive Manufacturing	21
The Additive Manufacturing Opportunity	24
The Advantages of Additive Manufacturing	26
Agility: Rapid Prototyping and Design Iteration	27
Complexity in Design: Unique Geometries, Properties, and Single Step Manufacture	28
Mass Customization and On-Demand Production	30
Inventory Management and Legacy Parts	30
Cost	31
Sustainability: Reduced Material Waste and Energy Use	32
Hybrid Manufacturing	32
Distributed Manufacturing	33
Additive Manufacturing: Weaknesses and Challenges	34
Production Volumes and Scale	35
Strength and Material Properties (Anisotropy)	36
Quality Control and Product Certification	37
Labour-Intensive Post-Processing	38
Business Case Challenges (Especially for Metal AM) and Risk-Aversion	39
Lack of Skills and Qualified Personnel	39
Lack of Knowledge	40
Additive Manufacturing in Strategic Sectors	43
Advanced Manufacturing	44
• Automotive	44
• Aerospace	45
• Tooling and Other Manufacturing Applications	46
• Consumer Products	46
Health/Bio-sciences	47
Clean Technology	48
Architecture and Construction	49

Table of Contents (Continued)

The Canadian Additive Manufacturing Landscape	52
Canada's Place in the Global Additive Manufacturing Ecosystem	53
Supporting Additive Manufacturing in Canada	55
• The Role of Government	55
• The Role of Educational Institutions	58
Canada's AM Firms	61
Canada's Strengths in AM	62
Challenges for Canadian AM	67
• Risk Tolerance	67
• Difficulties in Quality Control, Certification, and Standardization	68
• Ecosystem Fragmentation	69
• Small and Supply-Chain Beholden Ecosystem	69
Case Study: Additive Manufacturing in Germany	71
• Germany's AM Ecosystem	71
• The Roots of German Success in AM	72
• Lessons for Canada	74
The Demand for AM Talent	77
Anticipated Hiring	78
Talent Availability	79
In-Demand Roles	79
Key Skills for In-Demand Roles	80
Education Requirements	82
Work Experience Requirements	83
The Impact of COVID-19 on Additive Manufacturing	85
Conclusion	89
Appendix	91
I. Research Methodology	91
• Secondary Research	91
• Primary Research	91
II. Limitations of Research	92
III. Other Organizations involved in AM in Canada	92
• Research Centres	92
• Industry Bodies and Associations	94

Glossary of Key Terms

This glossary presents an overview of terminology used but not fully expanded upon in the text. For a more in-depth explanation of “Additive Manufacturing,” please consult Section 1.

Additive Manufacturing (AM, 3D Printing, 3DP): A category of manufacturing processes sharing the same iterative, layer-based approach. An object or part is first conceived as a Computer-aided Design (CAD) model and then brought into physical form by adding material layer by layer.^{1,2} The word *additive* serves to contrast this category of manufacturing processes from traditional *subtractive* (machining, milling) and *formative* (casting, stamping, injection moulding) manufacturing.

Advanced Manufacturing: The use of innovative technology to improve products or processes. Advanced Manufacturing aspires to create innovative and exciting products with higher levels of design and technical complexity, flexibility, and multi-functionality. Additive Manufacturing is one of many technological innovations enabling the Advanced Manufacturing paradigm; other key innovations include high-performance computing, high-precision technologies, advanced robotics, and automation.

Algorithmic Design: A form of design process that uses a machine to automatically create complex designs by replicating simple, recursive figures (as opposed to creating a complex design manually). Algorithmic Design pairs well with certain forms of AM due to the “free complexity” it offers.

Anisotropy: Occurs when a material, substance, or structure exhibits variations in physical or mechanical properties along different directional axes. It is a feature of most additive manufacturing processes, where objects are constructed layer upon layer. In Additive Manufacturing, the most common consequence of Anisotropy is that the print is weaker in the build direction than in the non-build directions due to the presence of small gaps between the applied layers. The degree of Anisotropy in a 3D-printed object depends chiefly on the build materials and process used to bond the layers together.

Bioprinting: The combination of 3D manufacturing techniques with biomaterials such as cells and growth factors. Bioprinting can be used to create structures that imitate the biological tissues found in nature. Several methods of Bioprinting exist based on extraction, inkjet, acoustic, or laser technologies.

Build Chamber: The enclosed space within an additive manufacturing system or 3D printer where parts can be fabricated. Exactly what the Build Chamber contains depends on the process. But across all processes, the Build Chamber always contains a Build Platform and an instrument for manipulating the printing material.

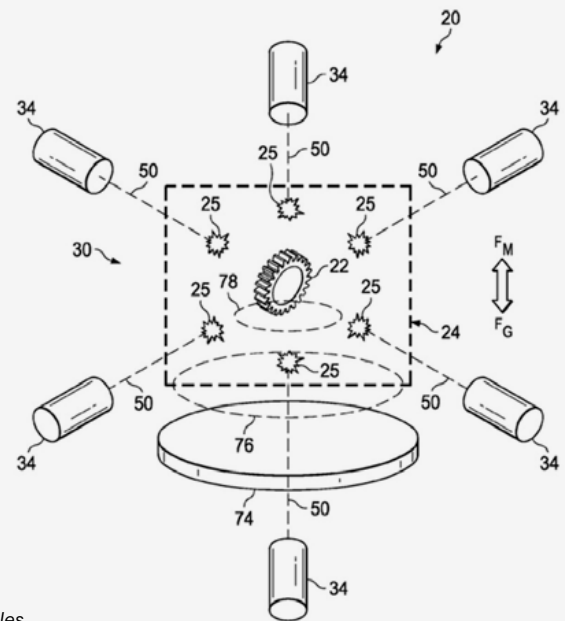

FIG. 11

- ¹ “ISO/ASTM 52900:2015 – Additive Manufacturing – General Principles – Terminology,” ISO, 2015. <https://www.iso.org/standard/69669.html>
- ² The terms Additive Manufacturing and 3D printing are used interchangeably throughout this report.

Build Platform (Build Area): The base within a 3D printer's Build Chamber that provides a surface for the printing of the first layer, which then supports the subsequent built up layer by layer.

Build Surface: The area within a 3D printer where new material is added to form a 3D-printed structure. At the start of most 3D printing processes, the Build Surface is the build area, but this changes as the printing processes advances. In techniques such as material extrusion or material jetting, the most recently printed layer acts as the foundation for the next layer of printing. In other processes, like Powder Bed fusion, the Build Surface is the location where fresh powdered material is added to be fused into the previous layers.

Catalyst: In Additive Manufacturing, a chemical that facilitates the curing process.

Computer-Aided Design (CAD): In manufacturing, refers to the use of computers in the design of an object to be produced. CAD involves creating computer models, defined by geometrical parameters, that produce a 3D representation of the part being designed. The design can be analyzed, modified, and optimized by changing the relevant parameters. CAD software allows designers to view objects under a variety of representations and test designs by simulating real-world operating conditions. It can also output the design as an electronic file with information on materials, processes, dimensions, tolerances, etc. These files can be fed into automated manufacturing systems (including 3D printers) and interpreted by the machine's software to produce the part.

Curing: A chemical process that results in the hardening and transformation of a liquid polymer material into a solid by inducing the cross-linking of polymer chains. Curing is induced by heat or electromagnetic radiation and may be facilitated by a Catalyst.

Distributed Manufacturing (Distributed Production, Local Manufacturing): A form of decentralized manufacturing in which manufacturers use a network of geographically dispersed facilities that are coordinated using information technology. Also, local manufacture at homes or small-scale facilities that adopts the "cottage industry" model.

Feedstock: Bulk raw material that is fed into the Additive Manufacturing system to build the component layers of the final part. Feedstock for Additive Manufacturing can be made from various materials including plastics, pure metals, metal alloys, resins, ceramics, wax, and paper. It also comes in various forms including filaments and wires, liquids and slurries, powders, pellets, inks and other suspensions, sheets, tapes, and foils.

Formative Manufacturing: Refers to the family of manufacturing processes that make use of material deformation (rather than material removal, as in subtractive manufacturing, or material addition, as in additive manufacturing) to create products. Casting, stamping, and injection moulding are the most common formative processes.

Generative Design: An iterative design exploration process in which a software program (often in CAD) generates a certain number of outputs that meet certain design constraints, and a designer fine-tunes the constraints to reduce or augment the number of outputs to choose from. Generative Design software often implements artificial intelligence, using algorithms to produce many design alternatives and machine learning to better refine and assess the resulting design outputs. Combining Generative Design tools with the flexibility of AM methods can help advance innovative solutions that lie outside of conventional design practices (in fields such as manufacturing, engineering, architecture, and construction).

Industry 4.0 (Fourth Industrial Revolution): The ongoing automation of traditional manufacturing and industrial practices, enabled by Machine to Machine (M2M) communication and Internet of Things (IoT) sensors.

Original Equipment Manufacturer (OEM): A manufacturer of systems and components that are used in another company's end-product. Common examples include microchips, processors, and sensors used in computers and other electronics. In the Additive Manufacturing ecosystems, "OEM" designates a) manufacturers of printers and systems that are then customized by Value-Added Resellers (VARs), and also manufacturers of hardware or software used in printers; and b) large potential purchasers of Additive Manufacturing services that manufacture original/proprietary equipment used in various sectors.

Photopolymers or Light-Activated Resins: Polymers that undergo curing when exposed to ultraviolet or visible light. Exposure to light creates cross-links between chains in the polymer, converting it from a fluid state to solid.

Photopolymerization: The use of light, whether visible or ultraviolet, to initiate a Polymerization reaction. In a Polymerization reaction, short polymer chains link together via covalent bonds to form either long polymer chains or a cross-linked structure.

Post Processing: Steps taken after the completion of a 3D printing run to achieve the desired properties in the finished product. Common examples include the removal of support structures, cleaning, sanding, smoothing, polishing, coating, electroplating, and firing in a kiln or furnace.

Powder Bed: A build platform that is filled with powder feedstock and used in certain types of additive manufacturing processes. As the printing run progresses, the powder bed typically descends, allowing a powder roller to spread additional layers of fresh powder on top, which are bonded to the underlying part using a thermal source or chemical adhesives.

Print Head: The component of a 3D printer that moves across the Build Surface and deposits the printing material layer by layer. Print heads are not included in all 3D printers, such as those that work by Powder Bed fusion or direct energy deposition.

Prototyping: An experimental (and usually iterative) process where design teams turn ideas into tangible form. A Prototype is a physical representation of a component or a product that may not have all the features of the final product but can be used for analysis, design, and evaluation. Prototypes are used to test, improve, and optimize designs before final production.

Thermoplastics: Materials, usually plastic polymers, which soften under heat and harden when cooled. Thermoplastics can be heated and cooled several times without modifying their mechanical or chemical properties.

Tooling: The process of producing or acquiring components that are used as tools to manufacture other goods in bulk. Tooling includes the production of moulds and dies (presses), gauges, jigs, fixtures, and cutting tools.

Subtractive Manufacturing: A category of manufacturing processes based on the removal of material from a solid block. Machining and milling are the two main types of Subtractive Manufacturing. Subtractive Manufacturing can either be performed manually or with a CNC machine (in which toolpaths are programmed beforehand and interpreted by the machine, eliminating much of the human interaction with the material).

Support Structure: A portion of a 3D-printed object that is included in the design not for function or aesthetics, but to support the printing of the other components of the object. After the print is complete, the Support Structure is removed. As most forms of 3D-printing involve building by layers, portions that stick sharply out from the part below (such as the top portions of the letters "T" and "Y" or the horizontal portion of an "H") usually will not have sufficient support below them to be printed. The Support Structure in a 3D print may take various forms depending on the design of the object, including columns, tree-like structures, and linear or accordion designs. Support Structures are necessary to realize many 3D designs, but it adds to costs—both directly through excess material and indirectly by increasing printing and post-processing time. Support Structures also raise the risk of damaging the printed part, as the support structure needs to be removed from the other printed material using mechanical or chemical processes.

Value-Added Reseller (VAR): A company that provides after-sale services or customized products to end customers. VARs are in the middle of the value chain between OEMs and a final customer. VARs notify potential customers about the applications of Additive Manufacturing, keep in touch with the needs of various markets, give OEMs feedback on their products, and provide value-added services to customers such as training or design consultation.

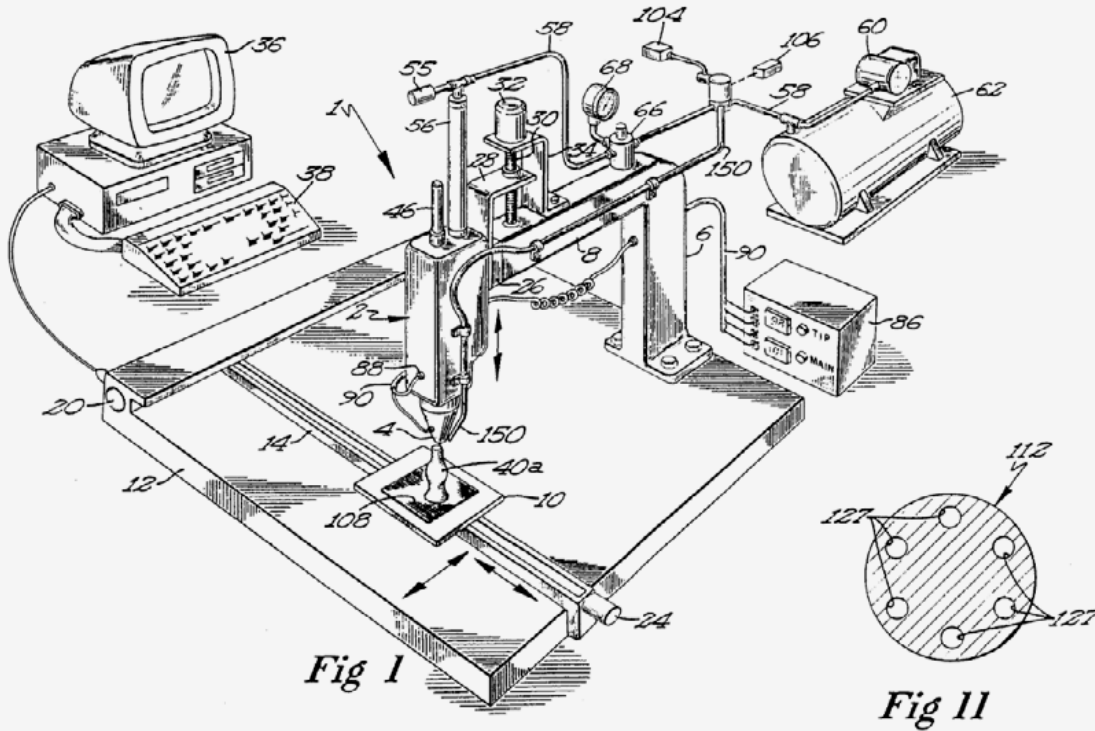

List of Acronyms Used in this Report

3D	Three-Dimensional
3DP	Three-Dimensional Printing
AC	Advisory Committee
AI	Artificial Intelligence
AM	Additive Manufacturing
ASTM	American Society for Testing and Materials
CAD	Computer-Aided Design
CNC	Computerized Numerical Control
DfAM	Design for Additive Manufacturing
EU	European Union
FDM	Fused Deposition Modelling
GDP	Gross Domestic Product
GE	General Electric
ICTC	Information and Communications Technology Council
IRAP	Industrial Research Assistance Program
ISO	International Organization for Standardization
KII	Key Informant Interview
NRC	National Research Council
OECD	Organisation for Economic Co-operation and Development
OEM	Original Equipment Manufacturer
PPE	Personal Protective Equipment
R&D	Research and Development
ROI	Return on Investment
SLA	Stereolithography Apparatus
SLM	Selective Laser Melting
SLS	Selective Laser Sintering
SME	Small and Medium-sized Enterprise
STEAM	Science, Technology, Engineering, Art, and Mathematics
UK	United Kingdom
US	United States
VAR	Value-Added Reseller
VC	Venture Capital

Foreword

In 2010, I had my first hands-on experience with 3D printing in a Technology Access Centre at Sheridan College. At first a simple hobbyist, I tinkered and experimented without giving much thought to where the Additive Manufacturing (AM) industry was headed. Bit by bit, I became fascinated by the materials, the processes, and the apparently limitless possibilities they offered.

Ten years later, I have personally installed some of the world's most advanced AM technology in manufacturing facilities across Canada. As the manager of a 3D print centre, a researcher, and now as the Vice-President of a Value-Added Reseller, I've seen businesses at every stage of the adoption process foray into the world of AM. I've witnessed a movement spread like wildfire around the world, igniting the imagination of makers and doers, students and faculty, engineers and manufacturers. Whether they are startups or global organizations, businesses are constantly looking for ways to maximize profit, minimize downtime, and remain competitive. The capabilities of AM continue to advance rapidly, enabling us to add value to the product development process in unique ways. Canadian educational institutions are investing in AM to empower their students and train them for the next generation of manufacturing. Even manufacturers that have been in business for more than a century are using AM to change their business.

The COVID-19 pandemic has posed one of the biggest challenges to businesses in modern history and shown the fragility of global supply chains. In doing so, it has provided a crude proof-of-concept for AM. When the Government of Canada called on those with 3D printing capabilities to respond to the pandemic, Canadian manufacturers re-tooled their production lines to produce personal protective equipment (PPE), ventilator parts, and nasopharyngeal swabs. It has moved me to witness OEMs, VARs, schools, businesses, and entrepreneurs using their AM capabilities to aid frontline workers. The unique strengths of AM have been demonstrated across the world in this time of uncertainty. There is a real opportunity for us to fortify the entire Canadian economy by building dominance in AM.

In the coming years, AM will continue to push the boundaries of what we make and how we make it. Both challenges and opportunities abound. As you'll learn in this report, the Canadian AM ecosystem includes a diverse group of organizations, all with a part to play in driving the adoption of this transformative technology. As employers, educators, government bodies, and policymakers, we have the final say; it is up to us to decide the future of AM in Canada.



Hargurdeep (Deep) Singh, C.E.T.

Vice-President, Additive Manufacturing at CAD MicroSolutions Inc.

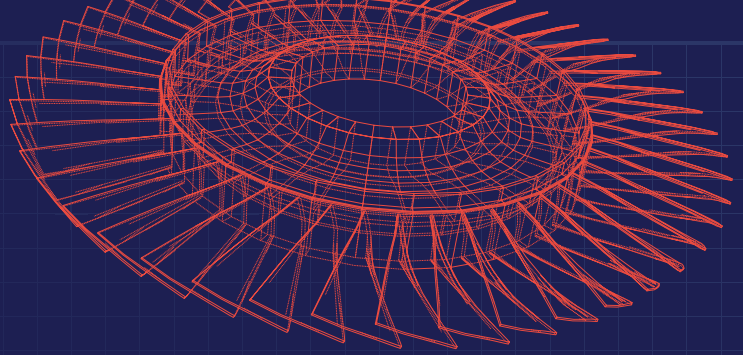

Executive Summary

Additive Manufacturing (AM) is poised to impact manufacturing paradigms throughout the global economy. Decades of technological advancement and falling costs have led to a proliferation of new use cases for the technology, and this rapid change is expected to continue. While in the early 2000s AM technology had slower uptake due to lower levels of funding and investment from industry, interest in the field has accelerated for the past decade. The global AM ecosystem is currently growing at 24% a year, putting it on track to reach US \$35.0 billion by 2024.³ This report explores AM technologies, noting their advantages and limitations, and their applications in key sectors. The report examines the strengths and weaknesses of its ecosystem, and exploring the diversity of firms, industry bodies, and educational institutions that make use of AM. Finally, it evaluates the impact of the COVID-19 pandemic on Canada's AM ecosystem and explores policies to promote growth, post-pandemic.

AM's advantages in production include agility, customizability, and flexibility. Best suited for the production of highly complex parts in low quantities, AM can be used to prototype rapidly, realize "impossible" geometries, optimize part design (particularly when paired with Generative or Algorithmic Design), and create custom parts on demand. It can also be incorporated into traditional manufacturing paradigms to facilitate conventional production via custom jigs and tooling, assist in the production of legacy components, and reduce costs in packaging, logistics, and inventory management. AM has become an established target for research and investment in numerous sectors, including health technology, biotechnology, manufacturing, and aerospace.

Despite these advantages and use cases, the global AM ecosystem currently represents less than 1% of the value of global manufacturing output, which was US \$13.8 trillion in 2019.⁴ Numerous technical and regulatory challenges will need to be addressed before AM claims a prominent place in the global manufacturing ecosystem. The adoption of AM will be influenced by a range of factors, including the scale and complexity of AM products, business models, existing manufacturing capabilities, and access to financial resources and technical talent. As AM technologies evolve, their adoption is expected to further increase.

Canada is a small power in the global AM ecosystem, which is currently dominated by China, the US, and the EU (particularly Germany). Canada has several world-renowned firms and notable success in several niches, including metal powder feedstock, metal AM research, and applications of AM to the aerospace and health science sectors. The Canadian AM ecosystem is highly diverse and includes OEMs, service bureaus, VARs, consultancies, startups, industrial adopters, and raw materials producers. The Canadian government supports the ecosystem through a range of research councils, accelerators, and funding programs. There are opportunities to leverage AM infrastructure at educational institutions across Canada to tackle high-risk R&D and facilitate training programs, while creating the R&D tech transfer pipeline to industry.

³ Tess Roberts, Alkaios Varotsis, Natasha Bukholt, et al. "3D printing trends 2020," 3D Hubs, 2020. https://downloads.3dhubs.com/3D_printing_trends_report_2020.pdf

⁴ Manufacturing, Value Added (current US\$), World Bank, 2019. https://data.worldbank.org/indicator/NV.IND.MANF.CD?most_recent_value_desc=true

Despite these opportunities, the Canadian AM ecosystem faces numerous challenges. Industry has been slow to adopt AM mainly due to cost and uncertain return on investment. Study interviewees noted a low uptake of government funding due to a lack of awareness of these resources and the complex processes required to access them. Participants also see funding programs as disproportionately focused on research, rather than adoption and further commercialization. Canadian firms are reliant on global leaders (especially China and the United States) for production supplies, machines, and technical services. Canadian firms typically face strong competition in these countries, which have commanding economies of scale and access to capital. Academic programs for the study AM in Canada, although already widespread, are currently at their inception and require sustained effort to ensure emergence; no institutions offer more than a couple of courses in AM and are often reserved for upper-level students. Due to high operations costs and lack of funding for educational program development, high-end AM industrial equipment typically serves as research infrastructure, and access to AM resources on campus is typically limited to consumer-level polymer printers.

Canadian AM organizations vary in the intensity at which they employ specialists in AM, with larger organizations more likely to be technology adopters than innovators. While hiring for AM roles accelerated markedly in the last three years, it appears to have declined recently due to the COVID-19 pandemic. Although growth in AM is widely expected to be rapid in the mid-term (around 20% per year),⁵ it builds from a relatively limited base; at present, few organizations in Canada use AM to make products at high quantities, and AM-focused roles make up a small percentage of jobs at organizations that adopt the technology.

Recent global supply chain and manufacturing disruptions have presented a unique opportunity for AM to step in and address unexpected gaps. Canada, like many countries, has seen a large-scale mobilization of AM capabilities to produce medical devices and PPE. Study participants noted that the COVID-19 pandemic and its related disruptions has helped raise awareness and acceptance of AM. The pandemic has allowed some firms in Canada's AM ecosystem to expand rapidly, but it also manifested as a short-term shock for others. While most Canadian AM organizations are not existentially threatened by the pandemic and its related shutdowns, the lessons learned during this period of turbulence can provide guidance for struggling organizations that rely on limited revenue streams, word-of-mouth advertising, face-to-face business, and complex or international supply chains.

Interventions that could help grow the AM ecosystem in Canada are numerous, encompassing investments in education and other forms of assistance. This could include providing students at all levels of education with hands-on exposure to industrial high-value equipment and creating a national AM strategy. At this point, Canada's AM ecosystem is at a crossroads; while technological advances and global market trends favour the continued growth of AM worldwide, and while Canada has high potential to exploit the growth of AM, there is no guarantee it will do so, given how dynamic and competitive the market is. With a strong, focused strategy and a set of industry-focused policies that exploit AM strengths, Canada can increase its chances of remaining a competitive player in this fast-moving industry.

⁵ See Figure 1: Additive Manufacturing Market Size—History and Forecast, p. 25.



Introduction and Background

What is Additive Manufacturing?

Additive manufacturing (AM), also commonly known as three-dimensional (3D) printing, is a category of manufacturing processes wherein an object or part is built by converting a digital version of the part into its physical 3D form by adding material layer by layer.⁶ The name additive manufacturing serves to contrast this category of manufacturing processes from traditional subtractive (machining, milling) and formative (casting, stamping, injection moulding) processes.

All AM processes follow the same basic workflow. Firstly, a digital model is created to act as the blueprint for the object being produced. Software then converts this 3D computer model into thin two-dimensional (2D) slices that are then printed in layers over top of each other using one or more electrical, mechanical, and chemical processes. Recent advancements in some AM processes^{7,8,9} are also beginning to allow for 3D printing of whole objects at once, circumventing the layer-by-layer approach and its related weaknesses.

Different types of AM processes have their respective advantages and limitations and allow for production in various materials such as plastics, ceramics, metals, and composites. The amount of time taken for a particular 3D printing run depends on several factors, including the size and complexity of the object being manufactured and the type of AM process and 3D printer being used.¹⁰ 3D-printed parts often also need some post processing (cleaning, smoothing, polishing, firing in a kiln or furnace, removal of support structures, etc.) before they are ready for use.

AM does not usually call for specialized tools or moulds because the final object is directly fabricated onto the build platform of the 3D printer. The set-up costs of AM processes are therefore relatively low, making it an economical option for prototyping and product development, low-volume production, and individual customization. With recent advances in 3D printing materials and feedstock and the refinement of AM technologies, there has been a proliferation of new use cases for AM. These advancements have also helped further bring down costs per unit. Although most AM production manufacturers use the technology for limited runs (hundreds of parts or fewer),¹¹ larger scale production is increasingly becoming economically viable. In a few cases, AM has been successfully adopted for serial production, ranging from tens of thousands to millions of units.^{12,13,14}

6 "ISO/ASTM 52900:2015 – Additive Manufacturing – General Principles – Terminology," ISO, 2015. <https://www.iso.org/standard/69669.html>

7 "Carbon3D introduces CLIP, breakthrough technology for layerless 3D printing," Carbon, 2015. <https://www.carbon3d.com/news/press-releases/carbon3d-introduces-clip-breakthrough-technology-for-layerless-3d-printing/>

8 Davide Castelvocchi, "Forget everything you know about 3D printing – the 'replicator' is here," Nature, 2019. <https://www.nature.com/articles/d41586-018-07798-9>

9 Damien Loterie, Paul Delrot, & Christophe Moser, "High-resolution tomographic volumetric additive manufacturing," Nature Communications, 2020. <https://www.nature.com/articles/s41467-020-14630-4>

10 "What is 3D printing? The definitive guide," 3D Hubs, 2017. https://downloads.3dhubs.com/3D_Printing_The_Definitive_Guide.pdf

11 "3D Printing At Scale: A Survey of 3D Production Manufacturing Stakeholders," Dimensional Research, 2019. https://www.essentium.com/wp-content/uploads/2019/10/3D_Printing_at_Scale_A_Study_by_Dimensional_Research_and_Sponsored_by_Essentium.pdf

12 Jon Bruner, Balazs Kisgergely, "The Digital Factory Report," Formlabs, 2019. <https://3d.formlabs.com/rs/060-UIG-504/images/The-Digital-Factory-Report.pdf>

13 Kristel Milet, "3D printing, from Chanel's new mascara brush to the current health emergency," Beauty News, 2020. <https://www.premiumbeautynews.com/en/3d-printing-from-chanel-s-new,16631>

14 "Erpro Group, pionnier de la production en série," L'usine nouvelle, 2020. <https://www.usinenouvelle.com/article/erpro-group-pionnier-de-la-production-en-serie.N1010154>



Additive Manufacturing: A Brief History

While some scholars theorized about AM processes as far back as the 1950s and 1960s, the first steps to it becoming a mainstream manufacturing process took place in the 1980s. In 1964, futurist and science writer Arthur C. Clarke envisioned a “replicator” capable of making objects “as easily as today we can make books.”¹⁵ In 1974, chemist and author David E. H. Jones published his “musings on new plastics fabrication processes” in his regular column Ariadne in the popular science magazine *New Scientist*.¹⁶ The article laid out the basic concept of 3D printing through photopolymerization. The earliest patents for AM methods and equipment were filed in Japan and France during the early 1980s, but the projects associated with these patents were abandoned due to lack of interest and funding.¹⁷

Innovation in AM started to flourish in the US during the mid-late 1980s and early 1990s. At this time, patents were granted for some of the most popular processes used today, including stereolithography (SLA),¹⁸ selective laser sintering (SLS),¹⁹ and fused deposition modelling (FDM).²⁰ The first commercial 3D printers were large and expensive, and they produced plastic parts with lower resolution and weaker physical properties than parts made using traditional manufacturing methods. These printers were therefore used mainly for industrial prototyping of non-critical functional parts, where mechanical properties were not crucial and the reduction in turnaround time and cost of product development justified the large initial investment required.

The late 1990s and early 2000s saw further development of AM technologies. Selective laser melting (SLM) technology was patented in Germany in 1996,²¹ laying the groundwork for the development of metal 3D printing. This period also saw initial developments in 3D bioprinting and AM in medical sciences, with pioneering research conducted at the Wake Forest Institute of Regenerative Medicine,^{22,23} and Clemson University.^{24,25}

¹⁵ “How was Arthur C. Clarke able to see into the future?,” BBC, 2018.

<https://www.bbc.co.uk/ideas/videos/how-was-arthur-c-clarke-able-to-see-into-the-future/p05tdpm6>

¹⁶ “Ariadne,” *New Scientist*, 3 October 1974, pg 80. <https://books.google.ca/books?id=nvabM3KXNsUC&pg=PA80>

¹⁷ Leo Greguric, “History of 3D Printing: When Was 3D Printing Invented?” *All3DP*, 2018.

<https://all3dp.com/2/history-of-3d-printing-when-was-3d-printing-invented/>

¹⁸ Charles Hull, “Apparatus for Production of Three-Dimensional Objects by Stereolithography,” *US Patent 4,575,330*.

United States Patent and Trademark Office, 1986. <https://patents.google.com/patent/US4575330>

¹⁹ Carl Deckard, “Method and Apparatus for Producing Parts by Selective Sintering,” *US Patent 4,863,538*. *United States Patent and Trademark Office*, 1989. <https://patents.google.com/patent/US4863538A>

²⁰ S. Scott Crump, “Apparatus and Method for Creating Three-Dimensional Objects,” *US Patent 5,121,329*. *United States Patent and Trademark Office*, 1992. <https://patents.google.com/patent/US5121329A>

²¹ Wilhelm Meiners, Dr. Konrad Wissenbach, Dr. Andres Gasser, “Shaped body especially prototype or replacement part production,” *DE19649865C1*. *German Patent and Trademark Office*, 1998.

<https://patents.google.com/patent/DE19649865C1/en>

²² “A Record of Firsts,” *Wake Forest School of Medicine*, 2020. <https://school.wakehealth.edu/Research/Institutes-and-Centers/Wake-Forest-Institute-for-Regenerative-Medicine/Research/A-Record-of-Firsts>

<https://school.wakehealth.edu/Research/Institutes-and-Centers/Wake-Forest-Institute-for-Regenerative-Medicine/Research/A-Record-of-Firsts>

²³ Matthew Whitaker, “The history of 3D printing in healthcare,” *The Bulletin*, 2018.

<https://publishing.rcseng.ac.uk/doi/pdf/10.1308/147363514X13990346756481>

²⁴ Charles Choi, “Ink-jet printing creates tubes of living tissue,” *New Scientist*, 2003.

<https://www.newscientist.com/article/dn3292-ink-jet-printing-creates-tubes-of-living-tissue/>

²⁵ Thomas Boland, William C. Wilson, Tao Xu, “Ink-jet printing of viable cells,” *Patent No. 7051654*. *Clemson Patents*,

[2006. https://tigerprints.clemson.edu/clemson_patents/218/](https://tigerprints.clemson.edu/clemson_patents/218/)

From the mid-2000s to the mid-2010s, AM became increasingly accessible and was adopted for more use cases than ever before. The RepRap project²⁶ was started in the UK in 2004 as an open-source initiative to build a “self-replicating manufacturing machine.”²⁷ In 2008, it released Darwin²⁸ – a 3D printer that could print 70% of its own parts (the rest being cheap, widely available electronic and mechanical components). Barriers to entry for innovators were further reduced with the expiry of patents on several key AM technologies.²⁹ This allowed for the emergence of a crop of new companies focused on the consumer 3D printing market and led to a drastic reduction in the price of desktop 3D printers. These developments spurred widespread interest in 3D printing and were key drivers in the growth of a “maker culture”³⁰ (a technology-based extension of DIY culture). The field received a further boost when US president Barack Obama. In his State of the Union address of 2013, the president flagged it as a driver for job growth and for revitalizing the manufacturing sector.³¹

As measured by Google searches worldwide, interest in 3D printing surged in the early 2010s and seemingly peaked around 2013, declining in the mid-2010s. There has since been a gradual ramping up of interest, further boosted in mid-2020 during the pandemic.³² Recent years have seen a readjustment of expectations and hype, and a shift in focus from widespread consumer adoption to manufacturing and industrial production. While some fanciful prognostications made during the 3D printing hype have not come to pass, there has been steady development in the underlying technology that is allowing for additive manufacturing in a wider range of materials, at lower cost, and with higher quality output.³³ With several recent advancements in metal 3D printing³⁴ and new breakthroughs using artificial intelligence, lattice structures, and complex geometries to optimize part design, weight, and performance,³⁵ AM is positioned for expansion and increased adoption in the coming years.

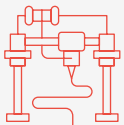

With Generative Design, Machine Learning, Intelligent Robotics, and Smart Materials combined to create a new generation of powerful design and engineering tools, a new, brighter horizon is emerging for Additive Manufacturing, one with a substantially lower barrier to entry. With [strong roots] in the CAD software industry and with its large and diverse talent in the field of artificial intelligence, Canada is very well positioned to be at the forefront of this revolution as a major provider of digital design technology, education, and manufacturing services—as long as targeted investment from the private sector and adequate support from the government are present.

– Executive, AM Software, Ontario

²⁶ “Welcome to RepRap.org,” RepRap.org, 2020. <https://reprap.org/>

²⁷ <https://www.cambridge.org/core/journals/robotica/article/reprap-the-replicating-rapid-prototyper/5979FD7BOC066CBCE43EEAD869E871AA>

²⁸ Zach Smith, “RepRapOneDarwin,” RepRap.org, 2007. https://reprap.org/wiki/RepRapOneDarwin#How_to_build_RepRap_1.0_22Darwin.22

²⁹ “How expiring patents are ushering in the next generation of 3D printing,” Tech Crunch, 2016. <https://techcrunch.com/2016/05/15/how-expiring-patents-are-ushering-in-the-next-generation-of-3d-printing/>

³⁰ Tim Bjarin, “Why the Maker Movement is Important to America’s Future,” Time, 2014. <https://time.com/104210/maker-faire-maker-movement/>

³¹ Doug Gross, “Obama’s speech highlights rise of 3-D Printing,” CNN Business, 2013. <https://www.cnn.com/2013/02/13/tech/innovation/obama-3d-printing/index.html>

³² Google Trends, 2020. <https://trends.google.com/trends/explore?date=all&q=3D%20printing,%2Fm%2F04rk8g>

³³ Mark Zastrow, “3D printing gets bigger, faster and stronger,” Nature, 2020. <https://www.nature.com/articles/d41586-020-00271-6>

³⁴ “Metal 3D Printing as an Enabler of Industry 4.0,” The Digital Factory, 2019. <https://www.thedigitalfactory.com/videos/metal-3d-printing-as-an-enabler-of-industry-4-0>

³⁵ Torsten Schnabel, Markus Oettel, and Dr. Bernhard Mueller, “Design for Additive Manufacturing: Guidelines and Case Studies for Metal Applications,” Fraunhofer IWU, 2017. http://canadamakes.ca/wp-content/uploads/2017/05/2017-05-15_Industry-Canada_Design4AM_141283.pdf

The Seven Families of Additive Manufacturing

The International Organization for Standardization (ISO) and the American Society for Testing and Materials (ASTM) have collectively presented seven main categories of AM processes, as per the latest standard: ISO/ASTM 52900:2015.³⁶ These are defined and compared in the table below.

Table 1: The Seven Families of Additive Manufacturing Processes^{37,38,39,40,41}

Compiled by ICTC, using multiple reference sources



TECHNOLOGIES



APPLICATIONS



MATERIALS



STRENGTHS & LIMITATIONS

1 BINDER JETTING

Liquid bonding agent is selectively deposited in thin layers to join powder material.

Similar to an inkjet printer, the print head moves over the build platform and deposits droplets of bonding adhesive. When a layer is complete, the powder bed moves down, a new layer of powder material is spread on the build platform, and the next layer is printed atop the previous one.

Full colour architectural models, packaging, etc.

Moulds and cores for sand casting

Low-performance, non-critical metal parts

Powdered Plastic
Metal
Ceramics
Glass
Sand and Gypsum

- Low production cost
- Relatively high speed
- No thermal distortion
- Printing in full colour
- Relatively poor mechanical properties
- Post-processing required

2 DIRECTED ENERGY DEPOSITION

Focused thermal energy is used to fuse materials by melting as they are being deposited.

This process is basically a form of automated build-up welding. Metal wire or powder is added to a melt pool that is created on the build surface using an energy source such as a laser or electron beam. The new metal fuses with the underlying layer to build up the part.

LMD: Laser Metal Deposition

LENS: Laser Engineered Net Shaping

DMD: Direct Metal Deposition

EBAM: Electron Beam Additive Manufacturing

WAAM: Wire Arc Additive Manufacturing

Repair and modification of existing or damaged metal parts

Near-net shape of large parts

Metal Wire and Powder
(Titanium, Stainless Steel, Aluminium, Copper, Tool Steel)

- Easier to produce large parts with multiple metals
- Better mechanical properties
- Cheaper feedstock compared to powder-bed metal AM
- High printing speed
- High capital cost
- Low resolution
- Poor surface finish
- Not ideal for certain geometries

³⁶ "ISO/ASTM 52900:2015 – Additive Manufacturing – General Principles – Terminology," ISO, 2015. <https://www.iso.org/standard/69669.html>

³⁷ "Quick Reference: 7 Families of Additive Manufacturing," Hybrid Manufacturing Technologies, 2015.

http://www.hybridmanutech.com/uploads/2/3/6/9/23690678/7_families_of_3d_printing_by_hybrid_v11_2p.pdf

³⁸ "Additive Manufacturing Technologies," 3D Hubs, 2020. <https://www.3dhubs.com/get/am-technologies/>

³⁹ Ben Redwood, "Additive Manufacturing Technologies: An Overview," 3D Hubs. <https://www.3dhubs.com/knowledge-base/additive-manufacturing-technologies-overview/>

⁴⁰ Cassidy Silbernagel, "Additive Manufacturing 101: What is it?" LinkedIn.

<https://www.linkedin.com/pulse/additive-manufacturing-101-what-cassidy-silbernagel/>

⁴¹ Mohammad Rafiee, Rouhollah D. Farahani, Daniel Therriault, "Multi-Material 3D and 4D Printing: A Survey," Advanced Science, 2020. <https://onlinelibrary.wiley.com/doi/pdf/10.1002/advs.201902307>



TECHNOLOGIES



APPLICATIONS



MATERIALS



STRENGTHS & LIMITATIONS

3

MATERIAL EXTRUSION *Material is selectively dispensed through a nozzle or orifice.*

Build material is extruded through a nozzle, syringe, or other orifice and deposited in thin layers as tracks or beads. The most commonly used processes involve thermoplastic filaments or pellets pushed through a heated nozzle (similar to a hot glue gun), or liquids/slurries pushed through a syringe.

FDM: Fused Deposition Modelling

FFF: Fused Filament Fabrication

PJP: Plastic Jet Printing

DIW: Direct Ink Writing

LPD: Layer Plastic Deposition

Prototyping
Packaging
Hobby kits & DIY
Aerospace air ducts
Jigs and fixtures
Medical applications

Thermoplastic Filaments and Pellets,
Liquids, Thermoset Resin, Biopolymers and Slurries

- Low set-up and production costs
- Easy operation with the option for in-office printing, without the need for a shop floor
- Relatively small printer size
- Susceptible to warping and delamination
- Can have relatively poor dimensional accuracy
- Visible layer lines in finish
- Strong anisotropy

4

MATERIAL JETTING *Droplets of build material are selectively deposited.*

Similar to an inkjet printer, the print head moves over the build area and deposits droplets of “ink”—photopolymers, or liquid suspensions of metal, wax etc.—to form a layer. Each layer is cured by exposure to heat or UV light before the next one is printed above it.

Polyjet

SCP: Smooth Curvatures Printing

MJM: Multi-Jet Modelling

NPJ: NanoParticle Jetting

DOD: Drop-on-Demand

High resolution visual and haptic prototypes in full colour
Moulds and patterns for lost-wax casting and mould making

Photopolymers
Polymers
Metal and Ceramic “inks”
Waxes

- Excellent resolution, detail, and surface finish
- Multi-material and multi-colour printing
- High set-up and production costs
- Poor mechanical properties

5

POWDER-BED FUSION *Thermal energy selectively fuses regions of a powder bed.*

A source of focused thermal energy—laser, electron beam, etc.—moves over a powder bed to fuse particles to the underlying layers through localized sintering or melting. After each layer is printed, the build platform is lowered, a fresh coat of powder is deposited on the powder bed, and the next layer is printed on it. At the end of the process, the completed part is retrieved from the bed of unfused powder.

SLS: Selective Laser Sintering

DMLS: Direct Metal Laser Sintering

DMLM: Direct Metal Laser Melting

SLM: Selective Laser Melting

EBM: Electron Beam Melting

SHS: Selective Heat Sintering

MJF: Multi-Jet Fusion

End-product manufacture of metal and plastic parts in various industries
Medical implants and surgical tools

Plastics
Metal and Ceramic Powders
Sand

- Excellent mechanical properties
- High resolution and complexity
- Relatively high energy consumption
- High set-up and material costs
- Surface roughness and initial finish dependent on feedstock quality
- May be prone to warping, shrinkage, and other thermal distortion
- More material wastage than other AM processes



TECHNOLOGIES

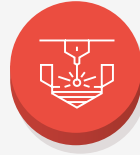

APPLICATIONS



MATERIALS



STRENGTHS & LIMITATIONS

6

SHEET LAMINATION

Sheets of material are bonded to form a part.

Thin sheets of material are stacked and laminated together to form the part. Depending on the process, each new layer is either first cut to shape and then bonded to the other layers, or vice versa. Based on the print materials, the bonding process can involve adhesives or other chemicals, ultrasonic welding, or brazing.

LOM: Laminated Object Manufacture
SDL: Selective Deposition Lamination
UAM: Ultrasonic Additive Manufacturing
CAM-LEM: Computer-Aided Manufacturing of Laminated Engineering Materials

Low-fidelity prototypes
Packaging
Parts with embedded OEM components
Production quality composite fibre and ceramic parts

Paper
Plastic Sheets
Metal Foils/Tapes
Ceramic and Composite Fibre sheets

- Relatively low cost, and high build rate
- Allows for multi-material printing, and for external components to be embedded
- Ability to print full colour with paper
- Post-processing required
- Higher waste compared to other AM processes
- Resolution dependent on thickness of feedstock

7

VAT PHOTOPOLYMERIZATION

Liquid photopolymer in a vat is selectively cured by light-activated polymerization.

Ultraviolet or visible light is either projected onto or traced over the build surface, which is submerged in a vat of liquid photopolymer resin. The region of the resin that is exposed to this light solidifies and fuses with the previous layers. The build platform is then moved allowing a new layer of resin to flow onto the build area, and the process is repeated to print the next layer.

SLA: Stereolithography Apparatus
DLP: Digital Light Processing
3SP: Scan, Spin, and Selectively Photocure
CLIP: Continuous Liquid Interface Production (also known as CDLP: Continuous Direct Light Processing)
2PP: Two-Photon Polymerization

Visual prototypes
Templates for low-run injection moulding
Surgical guides, orthodontic models, dental aligners, retainers, and prosthetics

UV or light-curable Photopolymer Resins (Plastics)

- High resolution, accuracy, and complexity
- Smooth surface finish
- Option for in-office printing without the need of a shop floor
- Brittle parts with limited mechanical strength and anisotropy
- Support structures are always needed, which require removal and post-processing
- Curling and other distortion

The Additive Manufacturing Opportunity

While initially used for rapid prototyping and testing, AM is now used for small-batch manufacturing, customization, repairs and spare part manufacture, and even some large-batch serial production.⁴² According to the Wohlers Report 2020,⁴³ the value of all AM products and services worldwide grew by 21.2% percent in 2019 to a total of US \$11.87 billion. The figure includes sales of industrial 3D printing systems, desktop 3D printers, feedstock materials, parts, software, and other services from vendors. This estimate of the AM market size represents a near doubling since 2016, when it was valued at US \$6.06 billion.⁴⁴ Studies by EY⁴⁵ and SmartTech⁴⁶ have found similar estimates for the size and growth of the AM market. Growth in AM is driven by both the adoption of AM technologies by new organizations and an increase in AM uptake among existing users of the technology.

Private and public investment in AM has also seen similarly impressive growth over the last few years. Venture capital (VC) investment in AM companies from 2016 to Q3 2020 has topped US \$4 billion.⁴⁷ In 2019 VC funding in AM startups had a record-breaking year, with over US \$1 billion invested.⁴⁸ Given the economic turmoil and volatility in financial markets caused by the COVID-19 pandemic, 2020 is expected to see a scale back in VC deals. There has, nonetheless, been investment of over US \$600 million in AM startups through Q3, including major funding rounds for Canadian companies Equispheres⁴⁹ and Aspect Biosystems.⁵⁰ Similar growth has also been observed in mergers and acquisitions activity in the AM market with an increase in deals between traditional manufacturers, AM equipment manufacturers, and companies across the AM value chain.⁵¹

Much recent investment in AM has gone into industrial and production applications.⁵² Other salient trends emerging in the AM space include an increase in adoption among industrial users and an increase in adoption for end-part production.⁵³ More companies are also investing in AM, and those investments are more significant.⁵⁴ While there are still key challenges that need to be overcome for wider industrial adoption—increasing reliability, reducing raw material costs, especially for metal AM, and further promoting education and training on the various AM technologies—the overall outlook for the global AM market is positive.

⁴² Jon Bruner, Balazs Kisgergely, "The Digital Factory Report," Formlabs, 2019.

<https://3d.formlabs.com/rs/060-UIG-504/images/The-Digital-Factory-Report.pdf>

⁴³ "Wohlers Report 2020," Wohlers Associates, 2020. <https://wohlersassociates.com/2020report.htm>

⁴⁴ *Ibid.*

⁴⁵ Stefana Karevska, Dr. Christoph Kilger, et al. "3D printing: hype or game changer?," EY, 2019.

https://assets.ey.com/content/dam/ey-sites/ey-com/en_gl/topics/advisory/ey-3d-printing-game-changer.pdf

⁴⁶ "SmarTech Publishing Issues 2019 Additive Manufacturing Market Outlook," SmarTech Analysis, 2019. <https://www.smartechanalysis.com/news/smartech-publishing-issues-2019-additive-manufacturing-market-outlook/>

⁴⁷ "3D Printing Q3 Summary Card," Venture Scanner, 2020.

<https://www.venturescanner.com/2020/10/16/3d-printing-q3-summary-card/>

⁴⁸ Tess Roberts, Alkaios Varotsis, Natasha Bukholt, et al. "3D printing trends 2020," 3D Hubs, 2020.

https://downloads.3dhubs.com/3D_printing_trends_report_2020.pdf

⁴⁹ David Sali, "Ottawa's Equispheres lands \$17 M in new funding for high-tech metal powder," Ottawa Business Journal, 2020. <https://www.obj.ca/article/ottawas-equispheres-lands-17m-new-funding-high-tech-metal-powder>

⁵⁰ Meagan Simpson, "Aspect Biosystems Raises \$26 million CAD in Series A for 3D Printing of Human Tissues," Betakit, 2020.

<https://betakit.com/aspect-biosystems-raises-26-million-cad-in-series-a-for-3d-printing-of-human-tissues/>

⁵¹ Stefana Karevska, Dr. Christoph Kilger, et al. "3D printing: hype or game changer?," EY, 2019.

https://assets.ey.com/content/dam/ey-sites/ey-com/en_gl/topics/advisory/ey-3d-printing-game-changer.pdf

⁵² Sarah Goehrke, "Why Are Investors Pouring Millions into 3-D Printing?" Forbes, 2019. <https://www.forbes.com/sites/sarahgoehrke/2019/01/25/why-are-investors-pouring-millions-into-3-d-printing/#3ad0c6f67f94>

⁵³ Stefana Karevska, Dr. Christoph Kilger, et al. "3D printing: hype or game changer?," EY, 2019.

https://assets.ey.com/content/dam/ey-sites/ey-com/en_gl/topics/advisory/ey-3d-printing-game-changer.pdf

⁵⁴ "The State of 3D Printing: 2020 Edition," Sculpteo, 2020. https://info.sculpteo.com/hubfs/downloads/The%20State%20of%203D%20Printing_2020%20edition.pdf

Analysts expect the AM market to grow between 20% to 30% annually for the next few years, effectively doubling in size every three to four years. The following figure combines the AM market growth forecasts of several market analysts. It estimates that the AM market will be worth almost US \$35 billion by 2024.⁵⁵

Figure 1: Additive Manufacturing Market Size—History and Forecast

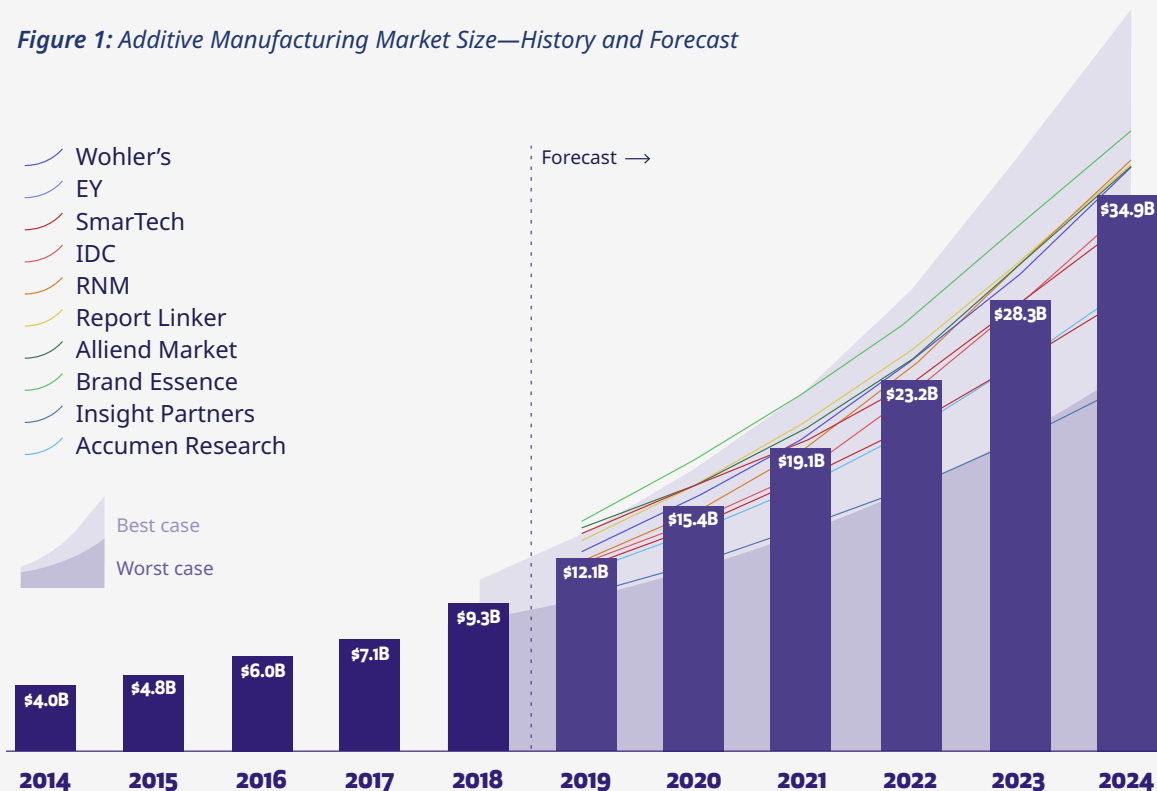

Source: “3D Printing Trends 2020: Industry Highlights and Market Trends,” 3D Hubs.⁵⁶

It is important to note that these forecasts were made prior to COVID-19 and the economic and financial disruption due to global lockdowns. Like most sectors, manufacturing (including AM) is expected to suffer a drop in demand and investment in the near-term, given the global macroeconomic slowdown. There are, however, encouraging signs for AM, as several of its key advantages—including agility, customizability, flexibility, and the relative resiliency of its shorter and simpler supply chains—have gained widespread attention amid global lockdowns and supply chain disruptions. While there is still uncertainty as to what the ultimate impact of the COVID-19 pandemic will be on AM, there is general optimism about the medium- to long-term outlook of the technology, despite some near-term setbacks.⁵⁷ This view is corroborated and elaborated upon in our primary research with AM experts in Canada, as discussed below, in the COVID-19 section of this report.

⁵⁵ Tess Roberts, Alkaios Varotsis, Natasha Bukholt, et al. “3D printing trends 2020,” 3D Hubs, 2020. https://downloads.3dhubs.com/3D_printing_trends_report_2020.pdf

⁵⁶ Ibid.

⁵⁷ TJ McCue, “Additive Manufacturing Industry Grows to Almost \$12 Billion in 2019,” Forbes, 2020. <https://www.forbes.com/sites/tjmccue/2020/05/08/additive-manufacturing-industry-grows-to-almost-12-billion-in-2019/#544683bc5678>



The Advantages of Additive Manufacturing

Interest and innovation in AM has been driven by its unique advantages over traditional formative or subtractive manufacturing and the shortcomings of these processes.

Agility: Rapid Prototyping and Design Iteration

AM allows for small-batch production with no tooling and set-up requirements. This advantage has allowed AM technology to be a commercially viable option for industrial prototyping and design testing from a very early stage in its own development. Rapid prototyping and design iteration are the oldest use cases for AM.⁵⁸ Creating prototypes using conventional methods would often take weeks or even months. AM processes can produce prototypes in a matter of hours, significantly speeding up product design and time to market. Decades of improvements in AM hardware, materials, and in operator skills have enabled much higher product quality, superior mechanical properties, improved production speeds, and lower costs. This has allowed a wider range of industries and participants—from multinational companies to high school students⁵⁹—to use AM for ideation and design.

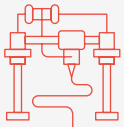

It's about agility and speed. We can quickly change our fixturing to support our needs. We can quickly go through the iteration process of development. That is very important to us.

– AM Lead, Aerospace, Atlantic Canada

The whole rapid prototyping thing is fantastic. It's great for the proof-of-concept stage. You can go from the concept and confirm that it will do what you need it to do before you invest all the time to produce the final product. If I were to contact an engineering firm, that would mean much more time and money.

– AM Designer, Freelance, Alberta

AM can be paired with design tools (software platforms) that incorporate various technologies to enhance the powers of the designer, including Generative Design, Artificial Intelligence (AI), and Algorithmic Design. AI can also be used to analyze build results and previous failures to make more efficient designs and reduce the likelihood of production failures.^{60,61} Another option is integrated solutions that allow for the entire design and manufacturing process to be accomplished on a single platform. Many interviewees see these platforms as essential to growing the acceptance of AM and the exploitation of its potential for design.

⁵⁸ K. K. Bernard Hon, "Digital Additive Manufacturing: From Rapid Prototyping to Rapid Manufacturing," *Proceedings of the 35th International MATADOR Conference*, 2007. https://doi.org/10.1007/978-1-84628-988-0_76

⁵⁹ Jean-Adrien Delicano, "3D printing offers Ontario students a foundation for 21st century skills," *Ontario Centres of Excellence*, 2018. <https://blog.oce-ontario.org/3d-printing-offers-ontario-students-a-foundation-for-21st-century-skills-d55eb4b72bdc>

⁶⁰ Jimeng Yang, Yun Li, Weidong Huang, et al. "Survey on Artificial Intelligence for Additive Manufacturing," *Proceedings of the 23rd International Conference on Automation and Computing*, 2017. https://www.researchgate.net/profile/Jimeng_Yang/publication/320824036_Survey_on_artificial_intelligence_for_additive_manufacturing/links/5a54fbf945851547b1bd5705/Survey-on-artificial-intelligence-for-additive-manufacturing.pdf

⁶¹ Peter Zelinski, "Where AM meets AI," *Modern Machine Shop*, 2019, pg 4, <https://drive.google.com/file/d/12uy4sh3nXA4IggpH4C0S7zSr4RSIIJKt/view>



AM doesn't give you many advantages if you do not know how to design things for AM. I believe that now the largest challenge is that there's a fundamental lack of design skills to leverage these technologies and that's holding back the usage of the technology. We also need to create smarter tools and smarter instruments.

– Executive, AM Software, Ontario

AM doesn't give you many advantages if you do not know how to design things for AM. I believe that now the largest challenge is that there's a fundamental lack of design skills to leverage these technologies and that's holding back the usage of the technology. We also need to create smarter tools and smarter instruments.

– Director, AM Software, Quebec

Complexity in Design: Unique Geometries, Properties, and Single-Step Manufacture

Applying material layer by layer, rather than milling, deforming, or injecting it into a mould, allows for complexity in design at a lower cost than in other manufacturing processes, enabling unprecedented freedom for designers. AM can be combined with generative and algorithmic design methods for even larger potential improvements in design possibilities.⁶²

Combined with its speed and agility, the design possibilities offered by AM make it the ideal technology to prototype, test, and compare complex design variations of any part or product. In the end, the part may be mass-produced either using AM or a traditional subtractive process; depending on the number of products required, the former may be faster and more cost effective. In some instances, AM might be the only way to realize the optimal design.

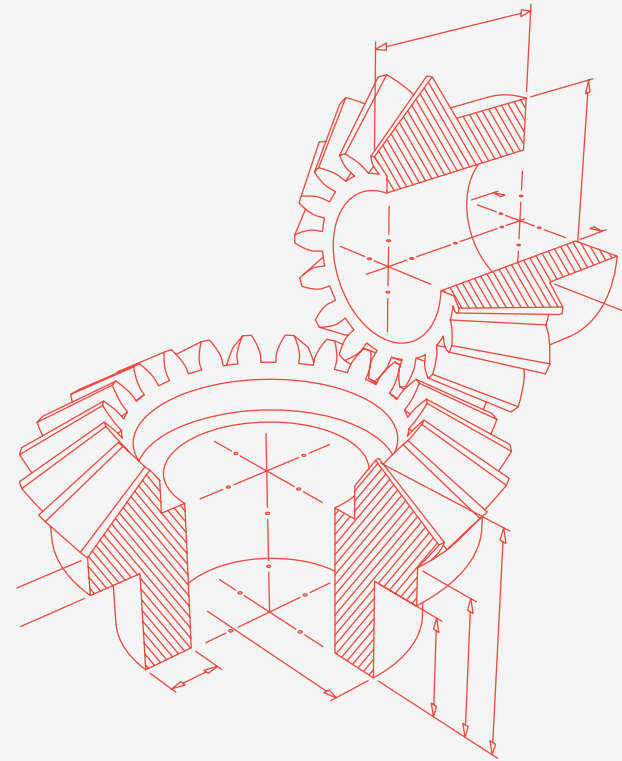

⁶² Anton Wiberg, Johan Persson, Johan Olvander, "Design for additive manufacturing – a review of available design methods and software," *Rapid Prototyping Journal*, 2019.
<https://www.emerald.com/insight/content/doi/10.1108/RPJ-10-2018-0262/full/html>

Another possibility, particularly valuable in industries such as aerospace and military equipment, is using complex geometries⁶³ and lattices.⁶⁴ These can reduce the amount of material required to strengthen a structure while providing other benefits (improved safety, for example, as the lattice can act as a shock absorber).⁶⁵ For parts created using subtractive methods, removing material to make parts lighter implies more processing and increased material waste, which increases costs. In AM, however, this added complexity comes at little to no additional cost and might even yield cost savings through a reduction in material needed for the final part.⁶⁶

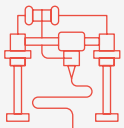

Finally, AM can be used to create prototypes and parts for designs that are cost-prohibitive or impossible using other manufacturing processes. Such “impossible” designs have been used to build nuclear reactors,⁶⁷ energy-efficient gas turbines,⁶⁸ heat sinks,⁶⁹ fluid flow models,⁷⁰ and medical implants with porous microstructures that can mimic natural tissue.⁷¹



We chose to work with AM because it enables us to operate with existing parts. We can reduce the amount of machining necessary on parts. It simplifies a range of processes. And large parts can be printed from scratch. Many degrees of freedom. We can manipulate our material in a more complex way.

– AM Specialist, Manufacturing, Quebec

From a design perspective, complexity is almost free. You can't print everything, but you can print almost anything.

– Engineering Manager, Construction, Quebec

⁶³ A W Gebisa, H G Lemu, “A case study on topology optimized design for additive manufacturing,” First Conference of Computational Methods in Offshore Technology, 2017. <https://iopscience.iop.org/article/10.1088/1757-899X/276/1/012026/pdf>

⁶⁴ “Rethinking foam – the Carbon lattice innovation,” Carbon, 2020.

<https://www.carbon3d.com/resources/whitepaper/rethinking-foam-carbons-lattice-innovation/>

⁶⁵ “3D printing helps create safer padding for helmets,” The Engineer, 2020.

<https://www.theengineer.co.uk/helmet-padding-combat/>

⁶⁶ “3D printing transforms the economics of manufacturing,” The Economist, 2017.

<https://www.economist.com/briefing/2017/07/01/3d-printing-transforms-the-economics-of-manufacturing>

⁶⁷ Daniel Oberhaus, “Coming Soon: A Nuclear Reactor – With a 3D-Printed Core,” Wired, 2020.

<https://www.wired.com/story/coming-soon-a-nuclear-reactor-with-a-3d-printed-core/>

⁶⁸ Chris Noon, “Hot off the press: 3D Printing Has Pushed This Gas Turbine to New Heights,” GE, 2018.

<https://www.ge.com/news/reports/hot-off-press-3d-printing-pushed-turbine-new-highs>

⁶⁹ Joris Peels, “CERN & 3D Systems 3D Print Parts for the Large Hadron Collider,” 3DPrint.com, 2020.

<https://3dprint.com/276380/cern-3d-systems-3d-print-parts-for-the-large-hadron-collider/>

⁷⁰ “Another Use for 3D Printing: Physically Modeling Fluid Flow Trajectory Lines,” Design News, 2020. <https://www.designnews.com/alternative-energy/another-use-3d-printing-physically-modeling-fluid-flow-trajectory-lines>

⁷¹ J. Ni, H. Ling, S. Zhang, et al. “Three-dimensional printing of metals for biomedical applications,” Materials Today Bio, 2019. <https://www.sciencedirect.com/science/article/pii/S259000641930050X>

Mass Customization and On-Demand Production

Improvements in the quality of 3D printed products and advancements in AM materials technology, have allowed for the rapid prototyping paradigm to be extended to the production of finished goods. AM now allows for customized and personalized products in a variety of materials to be produced quickly, and in a cost-effective manner. This is particularly valuable in cases where customization is beneficial or valuable, and consumers are willing to pay the premium for customized AM products over mass-produced, non-customized versions manufactured using traditional methods. Examples include medical devices and implants,⁷² orthodontics,⁷³ prosthetics,⁷⁴ and consumer goods such as footwear⁷⁵ and jewelry.⁷⁶ As AM hardware and feedstock becomes more economical, more use cases of mass customization are expected to become viable.



One of the chief benefits of 3D is that you don't have to retool. You don't have to build a part. Another advantage of AM is mass customization. You can build an entire line of ready-made products that are customized. You can't do that with a traditional assembly line.

– AM Consultant, Freelance, British Columbia

Inventory Management and Legacy Parts

AM allows for easy maintenance of complex products and one-off manufacture of replacement parts without having to hold them in physical inventory.⁷⁷ It also offers the added option of being able to upgrade to newer, more suitable materials to improve part reliability while keeping the same design to fit in legacy systems. This can help firms to reduce their inventory costs while also giving them options to upgrade the parts in older machines, allowing them to extend their lifespan.

⁷² "3D Printing of Medical Devices," US Food & Drug Administration, 2020.

<https://www.fda.gov/medical-devices/products-and-medical-procedures/3d-printing-medical-devices>

⁷³ "3D Printing in Dentistry," University of Toronto Libraries.

<https://guides.library.utoronto.ca/c.php?g=370430&p=5150683>

⁷⁴ "3D-Printable Prosthetic Devices," National Institutes of Health. <https://3dprint.nih.gov/collections/prosthetics>

⁷⁵ "Shoemakers bring bespoke footwear to the high street," *The Economist*, 2018. <https://www.economist.com/science-and-technology/2018/05/24/shoemakers-bring-bespoke-footwear-to-the-high-street>

⁷⁶ "How 3D Printing is Disrupting the Jewelry Industry," Formlabs, 2019.

<https://formlabs.com/blog/3d-printed-jewelry/>

⁷⁷ J. Jakob Heinen, Kai Hoberg, "Assessing the potential of additive manufacturing for the provision of spare parts,"

Journal of Operations Management, 2019. <https://onlinelibrary.wiley.com/doi/full/10.1002/joom.1054>

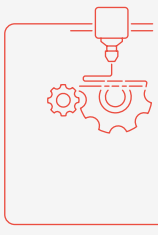

I went to a career fair in Comox and spoke with someone from the paper mills. I asked if they had an AM program in their facility. At first, the recruiter couldn't even understand how it worked. I discovered that they have an entire division dedicated to finding old paper processing machines. They buy the machine, then they transport the entire machine across the world and cannibalize it for parts. The Air Force search-and-rescue fleet does something similar; to maintain their fleets, they bought an entire fleet of helicopters just to cannibalize them for parts. AM is the logical solution to situations like this. It saves a ton of costs in parts.

– AM Consultant, Freelance, British Columbia

AM is an ideal technology for the spare parts market. For aircraft, the airframe can last for 60 years or more. But there are many engine components that need to be changed quite frequently. Parts need to be replaced, and we are in a position to provide parts ASAP to all our customers. But of course, having 300 or 400 parts per aircraft model in your inventory is very pricey. We are trying to print spare parts, as opposed to holding them in our warehouse. In the warehouse of the future, instead of 6000 parts, it would be so much easier just to have three printers with three different kinds of metal powders.

– Engineer, Aerospace, Quebec

Cost

AM allows for single-step manufacture with low set-up costs because no tooling or pre-processing is required (besides designing the part). Furthermore, AM processes can yield additional cost savings through design efficiency and reduced material, energy, shipping, and logistics costs. The cost advantages for AM are most pronounced for complex or highly customized goods but depend heavily on the specifics of the process and materials used.⁷⁸



I personally come from a machining background, and I saw that AM was a way to get crazy 3D shapes without you having to remove all that other material. It was often more efficient and just easier. For example, we're making a large 3D figurine. It's going to take around 300 hours to make and cost around \$1,000 in total; keep in mind, that's the retail cost—the production cost is \$500, just half of that. Now, to machine that, it would have cost [\$6,5000] and taken much, much longer to make.

– Executive, AM Consultancy, Ontario

⁷⁸ "3D printing transforms the economics of manufacturing," *The Economist*, 2017.
<https://www.economist.com/briefing/2017/07/01/3d-printing-transforms-the-economics-of-manufacturing>

Production quantity, however, impacts the cost advantage of AM versus traditional manufacturing. Injection moulding, for example, demands high upfront costs, followed by extremely low unit costs; the cost curve starts high and drops rapidly. By comparison, AM processes generally have lower upfront costs, but higher unit costs, resulting in a flatter cost curve. Accordingly, the cost advantage of AM relative to injection moulding usually diminishes for higher production quantities, if it does not disappear outright.^{79,80,81}

Sustainability: Reduced Material Waste and Energy Use

Manufacturing complex structures using traditional techniques (such as injection moulding or machining) often creates large amounts of wasted material, and removing this material also represents a waste of energy and productive time. AM's ability to create complex shapes layer by layer, enables such parts to be manufactured with significantly less material waste and energy and time spent in post processing, thereby giving it an advantage over traditional manufacturing in this area. AM can also play a role in reducing packaging and shipping costs, enabling certain products to be made onsite instead of having to be packaged and shipped over large distances.

Incorporating AM processes could improve resource efficiency across the entire product lifecycle.⁸² From product and process design to one-off component manufacturing, repair, refurbishment, and recycling, AM-based interventions can help improve the sustainability of products, processes, and systems. A recent study highlights several such examples of AM-driven commercial improvements that have been implemented around the world.⁸³



AM is a key for reducing the environmental footprint of manufacturing. Shipping plastic is hugely wasteful. For example, when we ship face shields, we pay more for shipping than the manufacturing itself. The environmental impacts are huge.

– Executive, AM Startup, British Columbia

Hybrid Manufacturing

According to a recent report by EY,⁸⁴ business leaders increasingly see AM as a complement to traditional manufacturing technologies and not as a replacement. The focus in recent years has been on exploring how AM can be embedded into existing manufacturing processes, systems, and workflows, and how new hybrid processes can be created.

⁷⁹ 3DPrintUK, 2020. <https://www.3dprint-uk.co.uk/low-volume-production-calculator/>

⁸⁰ "Making Injection Molding Cost-Effective: How Many Units Do You Need to Order?" 3DPrint.com, 2020. <https://3dprint.com/268013/making-injection-molding-cost-effective/>

⁸¹ Angela Linneman, "High-Volume 3D Printing Vs. Injection Molding," Shapeways, 2020. <https://www.shapeways.com/blog/archives/35860-high-volume-3d-printing-vs-injection-molding.html>

⁸² Simon Ford, Mélanie Despeisse, "The Role of Additive Manufacturing in Improving Resource Efficiency and Sustainability," *Advances in Production Management Systems*, 2015. https://link.springer.com/chapter/10.1007/978-3-319-22759-7_15

⁸³ Simon Ford, Mélanie Despeisse, "Additive manufacturing and sustainability: an exploratory study of the advantages and challenges," *Journal of Cleaner Production*, 2016. <https://doi.org/10.1016/j.jclepro.2016.04.150>

⁸⁴ "How 3D printing brings transformational change," EY, 2019. https://www.ey.com/en_gl/consulting/how-3d-printing-brings-transformational-change

Hybrid manufacturing seeks to combine AM with traditional subtractive processes, taking advantages of the relative strengths of each. Combining the toolless fabrication of AM with the precision of CNC milling allows for cost-effective small-batch production of complex metal designs, with a high degree of precision, low waste, and flexibility in material choice to allow for custom mechanical properties.⁸⁵



AM is a key for reducing the environmental footprint of manufacturing. Shipping plastic is hugely wasteful. For example, when we ship face shields, we pay more for shipping than the manufacturing itself. The environmental impacts are huge.

– Executive, AM Startup, British Columbia

Distributed Manufacturing

Another advantage of AM that is often cited by proponents is its ability to facilitate distributed manufacturing. AM could facilitate a decentralized, dispersed network of manufacturing sites that can better serve local markets, simplify supply chains, and greatly reduce lead times and shipping and logistics costs.^{86,87} Some of these advantages were brought to bear in the recent COVID-19 pandemic, when designers and manufacturers all over the world were able to rapidly iterate and design, and then locally print medical supplies including PPE and components for ventilators—all in the face of global lockdowns and supply chain disruptions.⁸⁸



It allows you to control a lot more within your country.

– Executive, Manufacturing, Ontario

Although AM does facilitate distributed manufacturing more than traditional manufacturing techniques, it does not necessarily eliminate factors that favour existing production patterns.⁸⁹ The economic case for distributed manufacturing is still not decidedly clear-cut, especially for industries with lower margins. A notable recent example is the sportswear manufacturer Adidas and its “Speedfactories” in Germany and the US.⁹⁰ Adidas launched these high-tech, heavily automated factories in 2017 to meet demand for faster delivery of new styles of its sneakers to major Western markets and to counter higher shipping and manufacturing costs at its manufacturing plants in Asia. These new plants were, however, shuttered in early 2020 and Adidas plans on moving production methods (including AM-based techniques) developed at these factories to two of its suppliers in Asia.⁹¹

⁸⁵ Marion Merklein, Daniel Junker, et al. “Hybrid Additive Manufacturing Technologies,” *Physics Procedia*, 2016. <https://doi.org/10.1016/j.phpro.2016.08.057>

⁸⁶ “Flexibility Redefined,” *Jabil*, 2019. <https://www.jabil.com/dam/jcr:2c53a0a4-939e-4aed-af29-c60c4933a77a/distributed-manufacturing-whitepaper.pdf>

⁸⁷ Rush LaSelle, “Seven Ways Additive Manufacturing Helps Accelerate the Production of Industrial Machines and Capital Equipment,” *Jabil*, 2020. <https://www.jabil.com/dam/jcr:9dd20f0a-417d-46e6-9838-669874be1113/additive-industrial-machines-white-paper.pdf>

⁸⁸ Albert Manero, Peter Smith, et al. “Leveraging 3D Printing Capacity in Times of Crisis: Recommendations for COVID-19 Distributed Manufacturing for Medical Equipment Rapid Response,” *International Journal of Environmental Research and Public Health*, 2020. <https://www.ncbi.nlm.nih.gov/pmc/articles/PMC7370126/>

⁸⁹ Emily Durham, “Could 3D printing lead to distributed manufacturing?” *Carnegie Mellon University*, 2019. <https://www.cmu.edu/news/stories/archives/2019/july/distributed-manufacturing.html>

⁹⁰ “3D printers start to build factories of the future,” *The Economist*, 2017. <https://www.economist.com/briefing/2017/06/29/3d-printers-start-to-build-factories-of-the-future>

⁹¹ “Adidas to close German, U.S. robot factories,” *Reuters*, 2019. <https://uk-mobile-reuters-com.cdn.ampproject.org/c/s/uk.mobile.reuters.com/article/amp/idUKKBN1XL16B>



Additive Manufacturing: Weaknesses and Challenges

While AM technology has made impressive strides in recent years to improve its value proposition, there are still several challenges that need to be addressed.

Production Volumes and Scale

In recent years, some major manufacturers have demonstrated the cost effectiveness of AM for full-scale factory production of certain complex products, including faucets,⁹² golf putters,⁹³ and mascara brushes.⁹⁴ Furthermore, recent innovations continue to increase printing speed, which is another disadvantage typically associated with AM.^{95,96,97}

However, the overall adoption of AM for large production runs has thus far been very modest. Numerous barriers currently prevent the use of AM for large-scale production. While “free complexity” is one of its main features, AM is not as cost effective as traditional methods for production runs with simpler designs.⁹⁸ While AM has relatively low tooling and set-up costs, making it economical for prototyping and low-quantity production, this also means that it does not benefit from the same economies of scale as traditional manufacturing does.⁹⁹ Given these limitations, the vast majority of participants in this study described AM as a technology that complements and enhances existing manufacturing methods, rather than replaces them.

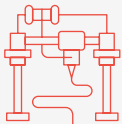

Yes, at the 10,000 to 50,000 level, AM is great, but for really high quantity [production], injection moulding will be dominant in the future. Now that being said, the quantity advantage of injection moulding is liable to decrease. We've increased our speeds by 10 times in just one year.

– Executive, AM Startup, British Columbia

Obviously, 3D is not ideal for everything. If you want a really strong part or to make something in vast quantities, it's best to injection mould. For use in plastic, 3D printing is ideal for small parts that are complicated in design. When you are in the right niche, 3D printing is faster, more reliable, and more cost effective.

– Executive, AM Startup, Ontario

⁹² Isaac Maw, “How Additive Manufacturing Can Compete in Full-Scale Factory Production,” *Engineering.com*, 2019. <https://www.engineering.com/AdvancedManufacturing/ArticleID/19336/How-Additive-Manufacturing-Can-Compete-in-Full-Scale-Factory-Production.aspx>

⁹³ Erik Matuszewski, “Cobra Golf, HP unveil 3D-Printed Putter, and Bryson DeChambeau had a hand in its development,” *Forbes*, 2020. <https://www.forbes.com/sites/erikmatuszewski/2020/11/17/cobra-golf-hp-unveil-3d-printed-putter-and-bryson-dechambeau-had-a-hand-in-its-development/?sh=664909f8791d>

⁹⁴ Lauren Murdoch-Smith, “Chanel Launches First Ever 3D-Printed Mascara,” *Vogue*, 2018. <https://www.vogue.co.uk/article/chanel-3d-printed-mascara>

⁹⁵ “Carbon3D introduces CLIP, breakthrough technology for layerless 3D printing,” *Carbon*, 2015. <https://www.carbon3d.com/news/press-releases/carbon3d-introduces-clip-breakthrough-technology-for-layerless-3d-printing/>

⁹⁶ Davide Castelvocchi, “Forget everything you know about 3D printing – the ‘replicator’ is here,” *Nature*, 2019. <https://www.nature.com/articles/d41586-018-07798-9>

⁹⁷ Damien Loterie, Paul Delrot, & Christophe Moser, “High-resolution tomographic volumetric additive manufacturing,” *Nature Communications*, 2020. <https://www.nature.com/articles/s41467-020-14630-4>

⁹⁸ Dr Harald Proff, Andreas Staffen, “Challenges of Additive Manufacturing: Why companies don't use Additive Manufacturing in serial production,” *Deloitte*, 2019. https://www2.deloitte.com/content/dam/Deloitte/de/Documents/operations/Deloitte_Challenges_of_Additive_Manufacturing.pdf

⁹⁹ “What is 3D printing? The definitive guide,” *3D Hubs*, 2017. https://downloads.3dhubs.com/3D_Printing_The_Definitive_Guide.pdf

Strength and Material Properties (Anisotropy)

AM is unique as a manufacturing process because, in an additive build, both the outer geometric form of a part and its internal material structure are created at the same time.¹⁰⁰ Building up layer by layer poses inherent limitations on the mechanical properties of 3D printed part, especially in processes where the layers are adhered using chemical or low-temperature thermal processes. One of the biggest challenges in AM is anisotropy, where the manufactured part possesses different mechanical properties (such as tensile strength) in the build direction versus other directions.

Anisotropy is not of itself a barrier to the use of AM as a reliable manufacturing material: indeed, materials such as wood and concrete are anisotropic and have been used for decades in construction. Furthermore, AM has been shown to be capable of producing high-performance functional parts for numerous sectors, including automotive,¹⁰¹ aerospace,^{102,103} and defence.¹⁰⁴ However, anisotropy is an issue in the use cases that AM most often competes in (such metal and non-reinforced plastics produced with traditional injection moulding) and may be regarded as a disadvantage or an undesirable design challenge. Recent advancements in material science may help overcome this problem.¹⁰⁵



There's a bit of a catch-22 going on where the true potential of additive can only really be actualized if there are materials that are developed exclusively for it, but at the same time, people are reluctant to develop materials exclusively for it precisely because it's a new technology that people still don't really trust.

– Engineer, Energy, Alberta

By definition, AM creates the isotropic problem. The properties of an object are more complicated—they change according to the direction the force is exerted on the object. This is not necessarily a problem. It depends on the application. That is just one of many challenges though.

– Postdoctoral Fellow, Education, Ontario

- ¹⁰⁰ Peter Zelinski, "Where AM meets AI," *Modern Machine Shop*, 2019, pg 4, <https://drive.google.com/file/d/12uy4sh3nXA4lggpH4COS7zSr4RSliJKt/view>
- ¹⁰¹ "Bugatti's 3D-printed brake caliper ready for the road," *CTV News*, 2018. <https://www.ctvnews.ca/autos/bugatti-s-3d-printed-brake-caliper-ready-for-the-road-1.4232168>
- ¹⁰² Sam Davies, "Premium Aerotec to produce A320 aircraft parts with GE Additive Concept Laser M2 machine after Airbus validation," *TCT Mag*, 2020. <https://www.tctmagazine.com/additive-manufacturing-3d-printing-news/premium-aerotec-a320-aircraft-ge-additive-concept-laser/>
- ¹⁰³ Michael Sheetz, "Relativity Space adds \$500 million to 'war chest' for scaling production of 3D-printed rockets," *CNBC*, 2020. <https://www.cnbc.com/2020/11/23/relativity-space-builds-war-chest-for-building-.html>
- ¹⁰⁴ Jen Judson, "US Army developing process for using 3D printing at depots and in the field," *DefenseNews*, 2020. <https://www.defensenews.com/land/2020/02/04/us-army-developing-process-for-using-3d-printing-at-depots-and-in-the-field/>
- ¹⁰⁵ Amy J. Clarke, "Designer alloy enables 3D printing of fine-grained metals," *Nature*, 2019. <https://www.nature.com/articles/d41586-019-03701-2>

Quality Control and Product Certification

An issue that has plagued AM for years is variability in the final build of 3D printed products. Production engineers and managers need to pay special attention to product consistency, i.e., dimensional accuracy and material properties such as porosity, strength, and temperature and chemical resistance.¹⁰⁶ This is particularly critical in use cases where part integrity is tied to safety, such as automotive, medical, or aerospace. Specifications and build quality in AM are affected by factors such as part design, feedstock quality, the AM process used, and printer optimization.¹⁰⁷ While current levels of consistency in AM are sufficient for various products—dental devices, optical lenses, non-weight-bearing metal, and plastic spare parts for locomotives, heavy industrial equipment, and airplanes, etc.—there is still room for improvement in AM hardware, software, and processes before AM can be more widely adopted for more demanding use cases.¹⁰⁸

Another major challenge is the development of global standards for AM materials, process control, and certification.¹⁰⁹ Since there are many variants of the AM process and their defects are very different from those in formative processes, the AM industry has been slow to define performance and reliability standards. Additive manufacturing involves several considerations from feedstock selection and qualification to design optimization and process selection. Each of these complex subtasks involves several parameters and decision variables that affect both hardware and software. These must be monitored, assessed, and controlled to ensure repeatability and reliability in production.¹¹⁰

Without industrial standards to define such parameters and create a set of benchmark criteria to measure process and output quality, AM production at a consistent level of quality can become a costly trial-and-error process. Well defined and globally accepted standards would also help facilitate and streamline the qualification and certification of AM produced parts for use in highly regulated industries such as aerospace, medicine, and automobiles. While these hurdles remain, investment in AM is likely to only be viable for businesses with a high risk tolerance and low effective cost of capital.

While the joint technical committee¹¹¹ of the International Organization for Standardization (ISO) and ASTM International has currently published 19 international standards,¹¹² these are primarily focused on general principles and part design. Boosting AM adoption and investment in wider applications will require an increase in globally accepted industrial standards focused on product testing, quality assurance, and qualification (beyond the 28 standards currently under development).¹¹³ An added challenge is the fact that technical advances that ensure high and reliable quality of production are often guarded as part of the service provider's intellectual property, stalling their adoption by the rest of the industry. It is therefore perhaps unsurprising that study participants described these difficulties as contributing to a reluctance among a broader base of consumers, entrepreneurs, policymakers, and investors to try AM-based products and business models.

¹⁰⁶ Richard D'Aveni and Ankush Venkatesh, "How to Make 3D Printing Better," *Harvard Business Review*, 2020. <https://hbr.org/2020/09/how-to-make-3d-printing-better>

¹⁰⁷ "What is 3D printing? The definitive guide," 3D Hubs, 2017. https://downloads.3dhubs.com/3D_Printing_The_Definitive_Guide.pdf

¹⁰⁸ Richard D'Aveni and Ankush Venkatesh, "How to Make 3D Printing Better," *Harvard Business Review*, 2020. <https://hbr.org/2020/09/how-to-make-3d-printing-better>

¹⁰⁹ "Developing Standards for 3D Printing: Where are We Today? (2020 Update)," AMFG, 2018. <https://amfg.ai/2018/10/19/developing-3d-printing-standards-where-are-we-today/>

¹¹⁰ *Ibid.*

¹¹¹ "ISO/TC 261 – Chairman Statement," ISO, 2021. <https://committee.iso.org/home/tc261>

¹¹² "Standards by ISO/TC 261: Published standards," ISO, 2021. <https://www.iso.org/committee/629086/x/catalogue/p/1/u/0/w/0/d/0>

¹¹³ "Standards by ISO/TC 261: Standards under development," ISO, 2021. <https://www.iso.org/committee/629086/x/catalogue/p/0/u/1/w/0/d/0>

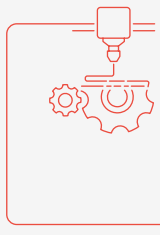

AM is incredibly delicate compared to traditional manufacturing processes. [In some cases] you are placing microns of material at a time. It is not at an assembly line level of consistency. I am from finance, and I was surprised at how operator-dependent 3D printing is. That means you need a ton of precision in both the hardware and the software. There is also the whole issue of settings and how the chemistry of the various materials can interact with the machine settings.

– Executive, AM Startup, British Columbia

Qualification is always going to be the hard part for additive parts—convincing people that it's worthwhile using these parts, especially for key infrastructure projects like bridges, ships – those things that, if they fail, go bad very quickly.

– Executive, AM Consultancy, Ontario

Labour-Intensive Post-Processing

Counterintuitively, labour is often the costliest component of AM processes.¹¹⁴ A 3D-printed part rarely comes out of the printer as a finished product. Technicians need to remove parts from the printer and put them through some form of post-processing— cleaning, smoothing, polishing, firing in a kiln or furnace, removal of support structures, etc.—before they are ready for use. To make AM economically viable in a wider array of production environments, the technology will need to decrease the time cost of post-processing, thereby freeing technicians to print more parts.¹¹⁵



We face technical challenges with post-processing. We always need post-processing in 3D manufacturing. That's a big technical challenge. Often the cost and time of post-processing can make additive cost more than subtractive manufacturing.

– Postdoctoral Fellow, Education, Ontario

One of the big things about AM is that there's still a manual [dimension to] it. Once it's done, you've got to dig it out, repeat, post-process, etc. It requires highly skilled people, but it's relatively repetitive.

– Production Manager, Consumer Retail, Atlantic Canada

¹¹⁴ Jon Bruner, Balazs Kisgergely, "The Digital Factory Report," Formlabs, 2019. <https://3d.formlabs.com/rs/060-UIG-504/images/The-Digital-Factory-Report.pdf>

¹¹⁵ Ibid.

Business Case Challenges (Especially for Metal AM) and Risk Aversion

AM may present high upfront costs despite technical innovations that continue to drive these costs down. Expertise in industrial AM is often very expensive to employ because it is scarce and often highly skilled (many having PhDs). Although consumer-focused “hobby” printers sell for as little as a few hundred dollars, printers for the industrial scale can often cost several hundred thousand dollars.¹¹⁶ In metal and concrete AM, costs of printers are even higher.¹¹⁷ The costs of other equipment, maintenance costs, and post-processing are also high. That said, many forms of equipment used in traditional manufacturing are also costly, so the challenge is not the cost per se but the high risk of investment in a new technology with an uncertain business case. Adoption of the most expensive, industrial-grade printers is limited to either large organizations that can absorb these costs in their research departments or ones that earn very high margins because of their industry (like aerospace or biomedical). High costs make it difficult for organizations that are not already dominant and well established to adopt AM beyond a superficial level, particularly small and medium enterprises (SMEs).¹¹⁸ Technical challenges such as ensuring consistent part quality, overcoming anisotropy, or producing in sufficient scale to make production cost effective (all mentioned in previous pages) also present obstacles to wider adoption and investment.



I think one of the biggest problems right now though for the industry, especially when it comes to metal AM or very advanced plastic AM, is the price point. Coming from industry, I've sat in dozens of budgetary meetings where we've discussed AM as a line item that we'd like to get to, but it's constantly coming down to ROI and how quickly we're going to see that return.

– Executive, AM Consultancy, Ontario

Lack of Skills and Qualified Personnel

AM is a multidisciplinary field that encompasses aspects of mechanical engineering, materials science, manufacturing and industrial engineering, mechatronics, robotics, software development, and industrial design.¹¹⁹ There are very few people equipped with AM skills, and in some fields such as Design for Additive Manufacturing (DfAM), the shortage of qualified professionals is especially acute.¹²⁰ Adding to these labour market challenges is the fact that AM processes can differ greatly from one another and that applications and materials also vary enormously across sectors. Therefore, skills from one type of AM process may not transfer to another. An in-depth exploration of the market for AM talent is included in the section titled “The Demand for AM Talent.”

¹¹⁶ Douglas S. Thomas, Stanley W. Gilbert, “Costs and Cost Effectiveness of Additive Manufacturing,” National Institutes of Standards and Technology, 2014. <https://nvlpubs.nist.gov/nistpubs/SpecialPublications/NIST.SP.1176.pdf>

¹¹⁷ Avetik Chalabyan, Elena Jaensch, et al, “How 3-D printing will transform the metals industry,” McKinsey & Company, 2017. <https://www.mckinsey.com/industries/metals-and-mining/our-insights/how-3d-printing-will-transform-the-metals-industry>

¹¹⁸ Joe Bauer, Patrick Malone, “Cost Estimating Challenges in Additive Manufacturing,” International Cost Estimating and Analysis Association, 2015. <http://www.iceaaonline.com/ready/wp-content/uploads/2015/06/MM01-Paper-Bauer-Additive-Manufacturing.pdf>

¹¹⁹ “3D opportunity for the talent gap,” Deloitte Insights, 2016. <https://www2.deloitte.com/us/en/insights/focus/3d-opportunity/3d-printing-talent-gap-workforce-development.html>

¹²⁰ Yuri Borgianni, Lorenzo Maccioni, Pasquale Russo Spina et al, “University Education in Additive Manufacturing and the Need to Boost Design Aspects,” Proceedings of the Design Society: International Conference on Engineering Design, 2019. <https://doi.org/10.1017/dsi.2019.67>

Lack of Knowledge

Numerous study participants cited a lack of understanding of what AM is capable of doing as a major barrier to the growth of the AM ecosystem, particularly because it stalls adoption by established organizations that could benefit from AM. In some of the most cutting-edge applications of AM, such as construction, there is such a gap of knowledge that entrepreneurs likened their efforts to sell AM to their customers as “speaking a different language.” Some SMEs and startups mentioned having to choose between investing in “marketing” AM and investing in their product.



We can't mount a multi-million-dollar campaign to educate people. If just half of the population of Canada knew what [AM is], and we could take a tiny slice of that business, we could be extremely profitable. But there is no awareness at this point, even in [our target market]. Obviously, companies we've done business with are aware and are excited about it, but it's all based on word of mouth, one interaction at a time. We're the only company in Canada that is doing this, so we are the only way that people find out about this.

– Engineering Manager, Construction, Quebec

I've tried to get a local company to look into AM, but for them, it's like I'm speaking a different language. They're unable to grasp it.

– Consultant, Construction, Ontario

Study participants perceived skepticism about AM as a major challenge to the growth of the ecosystem as a whole. They also mentioned their own businesses are hampered by this skepticism. The two most frequently cited perceptions they encounter are a) AM is only suitable for prototyping and cannot produce viable and robust end-use parts, and b) AM cannot be used effectively for large-scale production runs. Study participants said these views are historically valid but currently outdated. Skeptical views are frequently encountered in traditional manufacturing, the general public, and even among AM professionals. The high prevalence of these views certainly reflects some existing limitations of the technology (such as the difficulties of ensuring consistent part quality) but may also be compounded by the lack of skilled experts in the field (see previous header), the lack of AM-related information in the media (until recently), the fragmentation of the AM ecosystem, and the rapid speed of AM technological change (which makes it hard to stay informed).



I was one of the people who thought that additive manufacturing was just a toy technology—even though I did a PhD in AM! It's because that's the way the technology started.

– Postdoctoral Fellow, Education, Ontario

The general population doesn't really understand what additive manufacturing is. You say "Additive Manufacturing" and they have literally no idea. When you explain that it's 3D printing but on an industrial scale, they have a better idea. But they recoil because that brings up an image of people tinkering with 3D printers in their basement. They don't get that it can meet the demands of industry.

– AM Lead, Aerospace, Atlantic Canada

I have spent almost 30 years in this field, and I have encountered outdated views and baseless opinions too many times to count.

– Member, AM Association, Ontario

There's a big stigma against 3D. People think that it's only about prototypes, or that it's too expensive to do any meaningful production with it. It's funny, I give talks at industry events, and there's a guy I know who sells 3D printers. He does a great job promoting the sector. Anyway, he spoke at a conference about how 3D printing could only be used for prototyping. Right after him at the same conference, I spoke about how we can produce tens of thousands of parts. Afterwards, he came up to me and said that he had no idea that people like us existed.

– Executive, Startup, Ontario

On the other hand, many study participants also spoke of AM being “hyped” by enthusiasts who glossed over its weaknesses and pitched it as an all-purpose manufacturing solution, rather than a specialized tool. Some believed the industry had been complicit in this hype in the past (particularly around the early 2010s) and that AM's failure to live up to the hype resulted in some people getting “burned.” A few believed it was still common for AM firms to make false claims or misrepresent the capabilities of the technology.



People don't really know how 3D printing works. We have customers who sometimes come in and treat it like it's a magic process that will give them exactly what they want. As with all manufacturing processes, there are positives and drawbacks.

– Manager, Value-Added Reseller, Saskatchewan

There's a lot of false marketing claims out there. [One of our competitors] claims they can make a [product] for [X] dollars. It's actually more than twice that if you read the fine print, but they say that it will reach that price "someday." They just got millions in seed funding. We don't want to be trafficking in false claims, but it's obviously much easier to get interest if you make fantastical claims like that.

– Engineering Manager, Construction, Quebec



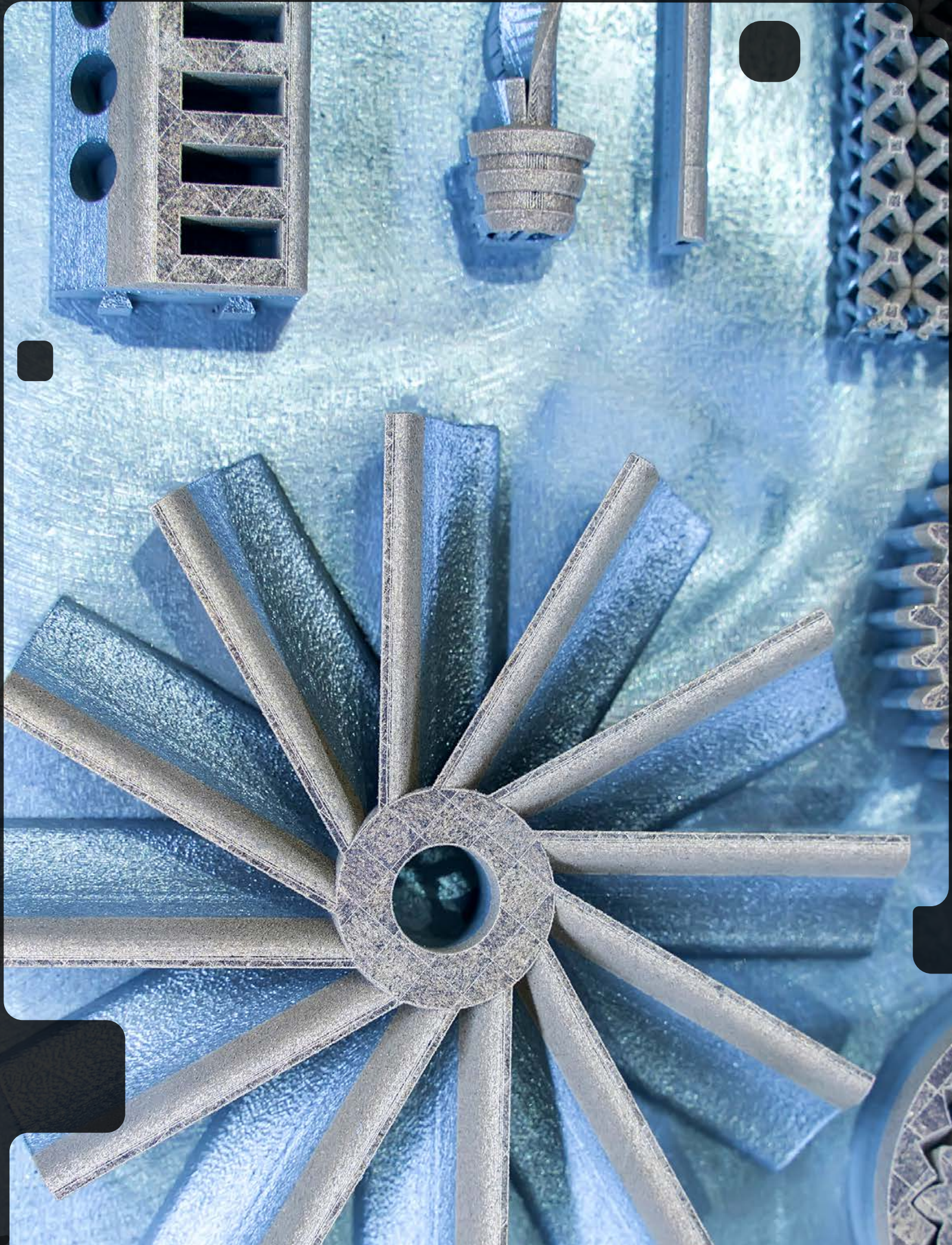

Additive Manufacturing in Strategic Sectors

Given the wide range of advantages that AM offers over traditional manufacturing processes, it is not surprising that there are numerous use cases in different stages of development across multiple industry sectors. At current costs and economics of AM technology, over 70% of AM's market value is comprised by four main industry sectors.¹²¹ The largest economic value for AM is currently in high value, low-volume production for sectors such as aerospace and automobiles or where customization is valuable, such as in medical/dental implants and consumer wearables. While there are many other use cases in other sectors, such as Transportation, Aerospace, Marine, Energy, and Food & Beverage,¹²² in this section, we look at some of the most common AM use cases in Canada's key strategic areas.¹²³



There are four main industries looking at AM: aerospace, auto, healthcare, tooling. In automotive, they focus on the design, because they want things to be cheap and light. AM helps them to reduce weight. In aerospace, they have an interest in lightweight components and advanced materials and functionality. In tooling, they really have an interest in using AM to make advanced tools. The biomedical sector is interested in making custom-made things like hip-replacements with advanced, biocompatible materials.

– Postdoctoral Fellow, Education, Ontario

Figure 2: AM Market Share, by Industry

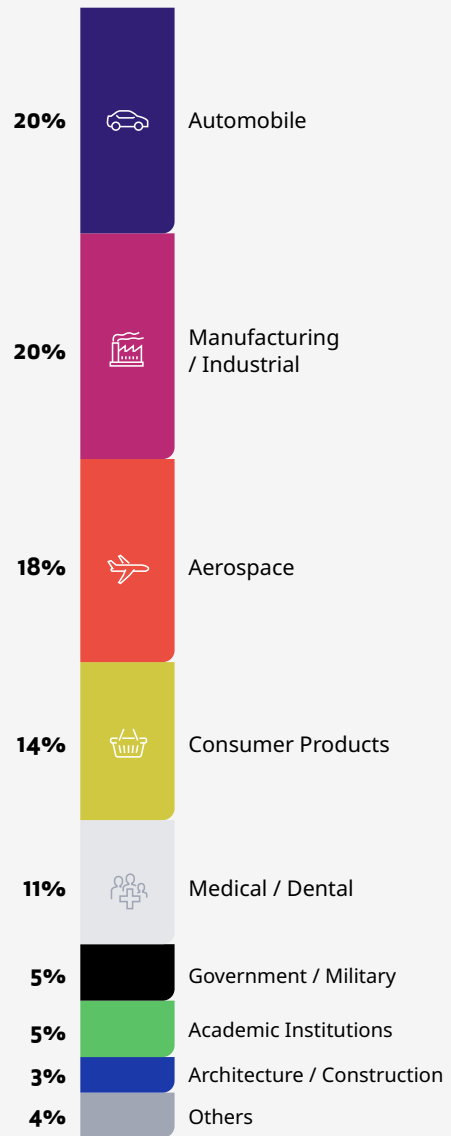

Source: Wohlers Report, 2019.¹²⁴

¹²¹ Marie-Pierre Ippersiel, Rene Poirier, et al. "Livre blanc sur la fabrication additive au Québec," Prima, 2020. https://www.prima.ca/wp-content/uploads/2020/06/Livre-blanc-Fabrication-additive-au-Qu%C3%A9bec_2020.pdf

¹²² "New Wohlers Report 2020 Documents more than 250 Applications of Additive Manufacturing," Wohlers Associates, 2020. <http://wohlersassociates.com/press82.html>

¹²³ "Economic Strategy Tables," ISED. <https://www.ic.gc.ca/eic/site/098.nsf/eng/home>

¹²⁴ "Wohlers Report 2019," Wohlers Associates, 2019. <https://wohlersassociates.com/2019report.htm>

Advanced Manufacturing

Advanced manufacturing is defined by the development and adoption of innovative technologies to create new products, enhance processes, and establish more efficient and cost-effective ways of working.¹²⁵ AM technologies are considered key advanced manufacturing technologies in Canada.^{126,127} Several common current AM use cases can be found in the automobile, aerospace, industrial manufacturing, and consumer retail sectors.



Automotive

In the competitive global automotive manufacturing sector, cost advantages can help participants boost profit margins and increase market share. Additionally, customizability can help generate niche demand, and design optimization can help improve vehicle performance and mileage.¹²⁹ AM is attractive in the automobile sector given its ability to facilitate cost-effective small-batch production, design and weight optimization, waste reduction, and the fabrication of complex parts in a single step. Common use cases in the automotive sector include rapid prototyping,¹³⁰ tooling,¹³¹ design optimization,¹³² and spare part manufacturing.¹³³ However, there is considerable reluctance to adopt the technology more widely, particularly for structurally essential end-use parts in mass production.



In the auto industry, it's all about quantity and production. This [AM] technology is not yet adapted to mass production.

– AM Specialist, Automation, Quebec

¹²⁵ "Advanced Manufacturing: The sector today and opportunities for tomorrow," Innovation, Science and Economic Development Canada, 2017.

[https://www.ic.gc.ca/eic/site/098.nsf/vwapj/ISED_C_Table_AM.pdf/\\$file/ISED_C_Table_AM.pdf](https://www.ic.gc.ca/eic/site/098.nsf/vwapj/ISED_C_Table_AM.pdf/$file/ISED_C_Table_AM.pdf)

¹²⁶ "Advanced Manufacturing: The sector today and opportunities for tomorrow," Innovation, Science and Economic Development Canada, 2017.

[https://www.ic.gc.ca/eic/site/098.nsf/vwapj/ISED_C_Table_AM.pdf/\\$file/ISED_C_Table_AM.pdf](https://www.ic.gc.ca/eic/site/098.nsf/vwapj/ISED_C_Table_AM.pdf/$file/ISED_C_Table_AM.pdf)

¹²⁷ "Advanced Manufacturing," Invest in Canada, 2020.

<https://www.investcanada.ca/industries/advanced-manufacturing>

¹²⁸ Alexandra Czok, Stefana Karevska, et al. "If 3D printing has changes the industries of tomorrow, how can your organization get ready today?" EY, 2016. https://assets.ey.com/content/dam/ey-sites/ey-com/en_gl/topics/advisory/ey-if-3d-printing-has-changed-the-industries-of-tomorrow-how-can-your-organization-get-ready-today.pdf

¹²⁹ Ibid.

¹³⁰ Kevin Quinn, "Driving differentiated value with additive manufacturing," Deloitte Insights, 2020.

<https://www2.deloitte.com/us/en/insights/industry/automotive/additive-manufacturing-for-automotive.html>

¹³¹ "Producing tire moulds using additive manufacturing," GE, 2020.

<https://www.ge.com/additive/industry/automotive/tire-mold>

¹³² "HRE Wheels is revolutionizing the wheel with additive manufacturing," GE, 2019.

<https://www.ge.com/additive/stories/hre-wheels-revolutionizing-wheel-additive-manufacturing>

¹³³ "Automotive and 3D printing: The Complete Guide to the 3D printed car!" Sculpteo, 2020.

<https://www.sculpteo.com/en/3d-learning-hub/applications-of-3d-printing/3d-printed-car/>

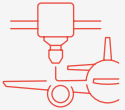

Aerospace

With extremely complex, high-performance parts that tend to be produced in lower volumes and at high cost, the aerospace sector was one of the earliest adopters of advanced polymer and metal AM technology. While prototyping is still the most popular use case in the sector, according to a survey by manufacturing services company Jabil, other common use cases include repairs and spare part production, end part production, tooling, and bridge production.¹³⁴ A promising area of development for the sector is in weight and design optimization facilitated by AM.¹³⁵ Every kilogram of weight saved in the aerospace sector can help save between US \$1,200 and US \$25,000.¹³⁶ AM also allows for component reduction by building complex designs not previously possible through subtractive methods, thereby reducing production times and costs.¹³⁷ These designs, coupled with the flexibility for mechanical properties that metal AM processes allow, can lead to better operational characteristics and increased efficiency.¹³⁸ The fact that most aircraft contain many large, complex, and expensive parts also favours the use of AM to produce spare parts, thereby reducing inventory costs.



In Quebec, we are very involved with aerospace. The aeronautic and aerospace [sector] is leading R&D in Quebec. You can change design completely, remove materials to reduce weight. That is very much desired by the aerospace industry. You can also add functionalities. In the deposition process, you can build parts with different components to vary properties. For example, you can use it to improve surface properties and increase tool life. It can be used for extrusion as well, dual extrusion and things like that. But, if you want to replace a part that is basically the same, it will usually cost less to replace it with a traditional technology.

– Project Manager, Research, Quebec

“The innovative design aspect of AM is of the most interest to us. You can use it to produce parts that would be impossible to produce any other way. You can use it to produce low volumes of parts quickly and with relatively low cost. Aerospace as a sector can deal with large, one-off costs are better than consumer products or automotive.

– Manager, Aerospace, Atlantic Canada

¹³⁴ “Aerospace and Defense Manufacturing Trends,” Jabil, 2019. <https://www.jabil.com/dam/jcr:1ede553e-5588-4dc0-9eb4-bab7f8d889b8/defense-and-aerospace-survey-report-v3.pdf>

¹³⁵ “Canada Makes, Burloak and MDA team up to create innovative satellite antenna parts,” Canada Makes, 2020. <http://canadamakes.ca/canada-makes-burloak-and-md-a-team-up-to-create-innovative-satellite-antenna-parts/>

¹³⁶ “3D printing transforms the economics of manufacturing,” The Economist, 2017. <https://www.economist.com/briefing/2017/07/01/3d-printing-transforms-the-economics-of-manufacturing>

¹³⁷ Robert Carter, Dr. Joe Grady, et al. “Additive Manufacturing of Aerospace Propulsion Components,” NASA, 2015. <https://ntrs.nasa.gov/archive/nasa/casi.ntrs.nasa.gov/20150023067.pdf>

¹³⁸ “For the ready. Take to the skies with proven metal additive solutions.” GE, 2020. https://www.ge.com/additive/sites/default/files/2020-09/GE_Aerospace_Brochure_8.5x11_R5.pdf



Tooling and Other Manufacturing Applications

Tooling, an industry which serves dozens of manufacturing-based sectors, aligns very well with the advantages of AM, particularly its ability to rapidly prototype, customize, and create highly complex objects.^{139,140} One particularly interesting use case is “end-of-arm” tooling (an aspect of robotic technology referring to equipment that interacts with parts and components) for robotic production and assembly lines.^{141,142}



For a lot of the tooling that we do, the tools couldn't be produced economically via traditional manufacturing. Lots of our parts are custom-made in small quantities. Even with higher volumes, the geometries of many of these parts are too complex for CNC to be effective. It's more to do with the intricacy of the parts than the volumes.

– Project Manager, Research, Quebec



Consumer Products

Consumer Products is another subsector of advanced manufacturing that is embracing AM technology. Key drivers for AM growth in this subsector include AM's ability to prototype quickly, facilitate mass customization, and its ability to respond to changing consumer tastes. These strengths are particularly desirable in dynamic markets such as fashion, accessories, novelties, wearables.¹⁴³



We make a lot of arts-related stuff. We use AM for sculpting. For example, we might make a 24-inch cube sculpture right now. Scale is not an issue. Going multi-component is really easy. We use this technology mainly for fan products.

– Executive, AM Consultancy, Ontario

¹³⁹ “Chapter 5 – Industrial Goods,” AMFG, 2020.

<https://amfg.ai/industrial-applications-of-3d-printing-the-ultimate-guide/#tab-con-15>

¹⁴⁰ Anton Alveflo, Nader Asnafi, et al. “Production Tools Made by Additive Manufacturing Through Laser-based Powder Bed Fusion,” *Berg Huettenmaenn Monatsh*, 2020. <https://link.springer.com/article/10.1007/s00501-020-00961-8>

¹⁴¹ Kip Hanson, “Additive Manufacturing and End Of Arm Tooling,” *Assembly Magazine*, 2016. <https://www.assemblymag.com/articles/93472-additive-manufacturing-and-end-of-arm-tooling>

¹⁴² “The future of manufacturing for the energy sector is being redefined,” *Canada Makes*, 2020. <http://canadamakes.ca/future-manufacturing-energy-sector-redefined/>

¹⁴³ Alexandra Czok, Stefana Karevska, et al. “If 3D printing has changes the industries of tomorrow, how can your organization get ready today?” *EY*, 2016. https://assets.ey.com/content/dam/ey-sites/ey-com/en_gl/topics/advisory/ey-if-3d-printing-has-changed-the-industries-of-tomorrow-how-can-your-organization-get-ready-today.pdf



Health/Biosciences

The health/biosciences sector has been another early proponent of AM technology. AM-based solutions can address some of the biggest challenges in the field. Bioprinting bionic limbs, replacement organs, and advanced pharmaceutical delivery systems that can respond to external stimuli could open further possibilities for smart implants and medical devices.¹⁴⁴ While many of these medical applications are still in the exploratory research and development phase, there are already several use cases of AM in the health/biosciences sector that are commercially viable and currently in use.¹⁴⁵

3D printing solutions can help healthcare practitioners and administrators visualize and plan complex interventions, create customized devices and implants with complex internal and external structures using biocompatible materials, streamline supply chains, and reduce costs.¹⁴⁶ Some current clinical applications of AM include creating anatomical models, customized implants and braces, surgical guides, tools and instruments, prosthetics, and dental applications such as dentures, aligners, and dental implants.¹⁴⁷ Bioprinting—3D printing of biocompatible materials, cells, and supporting components in complex 3D functional living tissues¹⁴⁸—is an exciting area of research and development, which has made several impressive breakthroughs in the last few years.^{149,150,151}

Canadian leadership in healthcare AM spans universities and research labs,^{152,153,154} hospitals,^{155,156} non-profit organizations,¹⁵⁷ and partnerships with private industry.^{158,159,160} Recently funded AM biotech enterprises in Canada include projects focused on improving the manufacture of customized orthopaedic implants¹⁶¹ and using bioprinting to develop novel strategies to treat brain diseases.¹⁶²

- 144** Ida Emilie Steinmark, Neil Goalby. "4D printing: the next dimension," Royal Society of Chemistry, 2020. <https://edu.rsc.org/feature/4d-printing-the-next-dimension-in-healthcare/4011689.article>
- 145** Emman Combella, Zita Jessop, et al. "20 – The commercial 3D bioprinting industry," *3D Bioprinting for Reconstructive Surgery*, 2018. <https://doi.org/10.1016/B978-0-08-101103-4.00029-6>
- 146** Jeff Mason, Teo Quay, et al. "An Overview of Clinical Applications of 3-D Printing and Bioprinting," CADTH, 2019. https://www.cadth.ca/sites/default/files/hs-eh/eh0072_3DPrinting.pdf
- 147** Ibid.
- 148** Sean Murphy and Anthony Atala, "3D Bioprinting of tissues and organs," *Nature Biotechnology*, 2014. <https://www.nature.com/articles/nbt.2958>
- 149** Kate Yandell, "Organs on Demand," *The Scientist*, 2013. <https://www.the-scientist.com/features/organs-on-demand-38787>
- 150** Mark Crawford, "Creating Valve Tissue Using 3-D Bioprinting," *American Society of Mechanical Engineers*, 2013. <https://www.asme.org/topics-resources/content/creating-valve-tissue-using-3d-bioprinting>
- 151** Nadav Noor, Assaf Shapira, et al. "3D Printing of Personalized Thick and Perfusable Cardiac Patches and Hearts," *Advanced Science*, 2019. <https://onlinelibrary.wiley.com/doi/full/10.1002/advs.201900344>
- 152** "3D Bioprinting generates encouraging future for healthcare," University of British Columbia Faculty of Applied Science, 2020. <https://apsc.ubc.ca/spotlight/research/3d-bioprinting-generates-encouraging-future-for-healthcare>
- 153** "About Us," Kinsella Lab, 2020. <http://kinsella.lab.mcgill.ca/>
- 154** "3D Printing Services for Clinical Research," McGill University Health Centre Research Institute, 2020. <https://rimuhc.ca/clinical-research/3d-printing>
- 155** Jodie Vanasse, "3D printing our way to better health care," *Ottawa Hospital*, 2017. <https://www.ottawahospital.on.ca/en/youre-in-my-care/3d-printing-our-way-to-better-health-care/>
- 156** "Who We Are," Institute for Reconstructive Sciences in Medicine, 2020. <https://irmsyeg.ca/services/>
- 157** "The Project," Victoria Hand Project, 2019. <https://www.victoriahandproject.com/>
- 158** "Helping innovative companies in British Columbia grow and compete," *Western Economic Diversification Canada*, 2018. <https://www.canada.ca/en/western-economic-diversification/news/2018/11/helping-innovative-companies-in-british-columbia-grow-and-compete.html>
- 159** "London researchers revamping jawbone surgery with 3D printing technology," *CBC News*, 2018. <https://www.cbc.ca/news/canada/london/3d-printing-adeiss-surgery-1.4806787>
- 160** Isabell Kirkwood, "Two Research Projects Receive Combined \$448,000 from Innovate BC," *Betaki*, 2019. <https://betakit.com/two-research-projects-receive-combined-448000-from-innovate-bc/>
- 161** "Canada's Manufacturing Supercluster and industry partners invest \$28.8 million in new and emerging technologies," *nGen*, 2020. <https://www.globenewswire.com/news-release/2020/07/08/2059487/0/en/Canada-s-Manufacturing-Supercluster-and-industry-partners-invest-28-8-million-in-new-and-emerging-technologies.html>
- 162** "New 3D therapeutic models of the blood-brain barrier could lead to improved treatments for Alzheimer's, ALS, and other central nervous system diseases," *National Research Council Canada*, 2019. <https://www.canada.ca/en/national-research-council/news/2019/02/the-national-research-council-of-canada-and-aspect-biosystems-work-toward-new-ways-to-deliver-therapeutics-to-the-brain-the-holy-grail-of-biopharma.html>

While there have been several enhancements to patient care and service delivery in healthcare that have been facilitated by AM, several technical, legal, and regulatory challenges still need to be addressed.¹⁶³ That said, 3D printing and bioprinting are some of the most promising avenues for development in health care, with several large clinical trials,¹⁶⁴ systematic reviews,¹⁶⁵ and research studies currently underway.¹⁶⁶



We have lots of interest from the aerospace industry. We have lots of R&D in Toronto and Montreal. We have around 4-5 research projects on the go, lots of industry partners from the aerospace industry. It's not yet a mature technology. It hasn't been totally accepted yet. But we're proving it can work and finding the right applications for it. The other interest comes from the biomedical field. They would use the technology on a much smaller scale to build things like implants. The idea is that the standards and the precision are similar.

– AM Specialist, Manufacturing, Quebec

One of the main drivers for the innovation and adoption of AM was the aerospace industry. And now that all the planes are grounded, we are not building any more engines, and we cannot count on them anymore to support the massive research and adoption of AM. At the same time, yes, medicine and healthcare might be a new leader. They were already very active in this field, but maybe it will be more important now.

– Technical Lead, Public Sector, Quebec

We sell all over the world, but our biggest market is probably is the United States. And in terms of industry verticals, we are in aerospace, defence, military... that whole group is a significant portion of our customer base... Some of the more interesting use cases that we see, are for biomedical purposes. But because of the nature of that industry, it's going to take longer for those applications to develop and start to scale.

– Executive, OEM, Quebec

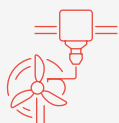

Clean Technology

The energy sector often utilizes large, complex machines that tend to have a long useful life, typically measured in decades. AM, with its inherent advantages in the areas of design complexity, weight optimization, and inventory and spare part management, allows for several improvements in current designs and processes in clean technology, resulting in less energy and material waste, increased efficiency, and reduced environmental impact.

¹⁶³ Witold Jamroz, Joanna Szafraniec, et al. "3D Printing in Pharmaceutical and Medical Applications – Recent Achievements and Challenges," *Pharmaceutical Research*, 2018.

<https://www.ncbi.nlm.nih.gov/pmc/articles/PMC6061505/>

¹⁶⁴ "International Clinical Trials Registry Platform," *World Health Organization*, 2020.

<https://apps.who.int/trialsearch/>, Keyword: "3D printing," Accessed on: 10 Nov, 2020

¹⁶⁵ *National Institute for Healthcare Research*.

<https://www.crd.york.ac.uk/prosperso/#searchadvanced>, Keyword:

¹⁶⁶ "3D printing," Accessed on: 10 Nov, 2020

Wei Sun, Binil Starly, et al. "The bioprinting roadmap," *IOP Science*, 2020.

<https://iopscience.iop.org/article/10.1088/1758-5090/ab5158>

Metal additive printing is used to produce gas turbines with more energy-efficient designs that could not previously have been achieved using traditional manufacturing. Such designs (also used in the aerospace sector) considerably reduce the amount of coolant needed by the parts, which leads to improved performance and yields potential savings of millions of dollars per year.¹⁶⁷ Another energy-efficient design only possible through AM methods has recently been realized by the US Department of Energy.¹⁶⁸ Researchers at the Oak Ridge National Laboratory are refining and testing a 3D-printed core for a nuclear reactor. The new design is expected to boost the energy efficiency of the reactor and will allow for embedded sensors, providing valuable insights on the internal conditions of the core during testing and operation.¹⁶⁹ Moreover, AM also allows for faster turnaround when making design changes and, critically, a significant reduction in the number of components to make the part. This, along with the vast amount of data collected through the embedded sensors, should help greatly reduce the time and expenditure required to certify the nuclear reactor for operation.¹⁷⁰

Another recent area of AM development in the cleantech sector has been in the 3D printing of solar cells.¹⁷¹ 3D printed solutions can help produce lightweight, flexible solar panels that can be integrated into a variety of form factors (a hardware design aspect that defines and prescribes the size, shape, and other physical specifications of components), and provide portable power solutions for remote communities.¹⁷² A recent research project has also led to the development of a 3D printed system that allows for significantly faster testing of solar cell designs and evaluation of the performance and commercial potential of new compounds being used in these cells.¹⁷³

Canada's cleantech sector includes AM metal powder manufacturer Equispheres, which received \$8 million in funding from Sustainable Development Technology Canada in January 2020 to scale production of its proprietary metal powders.¹⁷⁴ Its aluminium powder has been optimized for automobile and aerospace AM manufacturing to reduce vehicle weight and, by extension, their carbon footprint.¹⁷⁵ This latest development is the continuation of a trend of growing Canadian expertise in metal powder development.¹⁷⁶ Other Canadian cleantech companies include two firms in British Columbia: S&S Turbine, which uses AM to design, test, and produce spare parts for older turbine models,¹⁷⁷ and Advanced BioCarbon 3D, which converts slash (undesirable biomass from logging sites such as branches and small hardwood trees that are cut down but not harvested) into bioplastic polymers for use in 3D printers.¹⁷⁸

¹⁶⁷ "The Future of Additive Manufacturing," General Electric, 2018.

<https://www.ge.com/power/about/insights/articles/2018/07/additive-manufacturing>

¹⁶⁸ "3D-printed nuclear reactor promises faster, more economical path to nuclear energy," Oak Ridge National Laboratory, 2020. <https://www.ornl.gov/news/3d-printed-nuclear-reactor-promises-faster-more-economical-path-nuclear-energy>

¹⁶⁹ "Coming Soon: A Nuclear Reactor – With a 3D-Printed Core," Wired, 2020.

<https://www.wired.com/story/coming-soon-a-nuclear-reactor-with-a-3d-printed-core/>

¹⁷⁰ Ibid.

¹⁷¹ Vishal R. Mehta, Nuggehali M. Ravindra, "Screen Printing to 3D Printing of Solar Cells – An Overview," Research Gate, 2020. https://www.researchgate.net/publication/339234419_Screen_Printing_to_3D_Printing_of_Solar_Cells-An_Overview

¹⁷² "Printable solar cells for lightweight energy," CSIRO, 2020. <https://www.csiro.au/en/Research/MF/Areas/Innovation/Flex-Electronics/Printed-Solar-Cells>

¹⁷³ "3D-printed system speeds up solar cell testing from hours to minutes," Exciton Science, 2020.

<https://excitonscience.com/news/3d-printed-system-speeds-solar-cell-testing-hours-minutes>

¹⁷⁴ "Equispheres receives \$8 million in cleantech funding to scale metal powder production," Metal AM magazine, 2020. <https://www.metal-am.com/equispheres-receives-8-million-in-cleantech-funding-to-scale-metal-powder-production/funding>

<https://www.metal-am.com/equispheres-receives-8-million-in-cleantech-funding-to-scale-metal-powder-production/funding>

¹⁷⁵ "Cleantech Fund Accelerates Efficiencies in Automotive and Aerospace Industries with Metal Powder Innovation Investment," Businesswire, 2020. <https://www.businesswire.com/news/home/20200115005803/en/>

<https://www.businesswire.com/news/home/20200115005803/en/>

¹⁷⁶ Tomas Kellner, "Atomize This: Metal Powder From This Canadian Plant Will Fire Up The 3D Printing Revolution," General Electric, 2017. <https://www.ge.com/news/reports/atomize-metal-powder-canadian-plant-will-fire-3d-printing-revolution>

<https://www.ge.com/news/reports/atomize-metal-powder-canadian-plant-will-fire-3d-printing-revolution>

¹⁷⁷ "3D Printing/Additive Manufacturing," S&S Turbine Services Ltd, 2019.

<https://www.ssturbine.com/3d-printing-additive-manufacturing>

¹⁷⁸ "Transparent wood, 3D printing and stealth technology," Natural Resources Canada, 2019. <https://www.nrcan.gc.ca/our-natural-resources/forests-forestry/state-canadas-forests-report/articles/transparent-wood-3d-printing-stealth-technology/22288>

Architecture and Construction

AM is seen as a potential solution to several issues that currently ail the housing and construction sector in developed¹⁷⁹ and developing nations.¹⁸⁰ It has even been proposed as a potential solution to the housing and construction challenges in the Canadian North¹⁸¹ or as a cost-effective way of fighting homelessness.¹⁸² AM-based construction could offer several advantages over conventional construction processes, including complex and customized construction, reduced project times and material waste, and lowered costs.¹⁸³

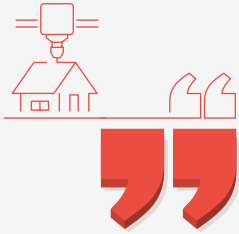

A wall that is R-6 costs the same as a wall that is R-20 (different thermal insulation values), enabling us to make buildings with different insulation levels for no additional costs. We just make the space between inner and outer layers as thick or thin as we need. There's no need to modify the procedure in any other way. There's no formwork. We have custom prints of whatever people want. It's possible to print two houses side by side without reconfiguring the printer set-up, and you could print a story every 8 hours. There is theoretically no limit to the number of stories that could be made.

– Engineering Manager, Construction, Quebec

AM in terms of cost is much lower, especially when you do it on a mass scale. For example, if you're printing one thing in metal or plastic or concrete, one item is not cost effective. But when you do it on a large scale, like 100 houses or 1000 houses, then it makes sense because you're paying for the technology once and you're paying for material once, and the material is usually local material. You're not importing large amounts of material from abroad. This is the reason why we tried this—because there's a big housing shortage in the world. We're looking at war-torn countries in order to try to build infrastructure as fast as possible when the people come back to their homeland. We're also trying to deal with the housing shortage in poor countries as well.

– Consultant, Construction, Ontario

Work recently began on the largest 3D-printed apartment building in Europe. Located in Bavaria (Germany), the project will use the fastest 3D construction printer on the market to build five apartments over a total 4,000 square feet of living space in six weeks.¹⁸⁴

¹⁷⁹ <https://digital.hbs.edu/platform-rctom/submission/additive-manufacturing-potential-solution-to-the-labor-shortage-in-construction/>

¹⁸⁰ Christina Zdanowicz, "3D-printed neighborhood being built in Mexico for families living on US\$3 a day," CTV News, 2019. <https://www.ctvnews.ca/sci-tech/3d-printed-neighbourhood-being-built-in-mexico-for-families-living-on-us-3-a-day-1.4728362>

¹⁸¹ Ken Coates, Carin Holroyd, "Revolutionary Building for the North: 3D Printing Construction," The Conference Board of Canada, 2018. <https://www.conferenceboard.ca/e-library/abstract.aspx?did=9949>

¹⁸² "An Austin startup can 3D-print tiny homes in 24 hours for a fraction of the cost of traditional homebuilding – here's how Icon could revolutionize affordable housing," Business Insider, 2020. <https://www.businessinsider.com/icon-3d-printer-tiny-home-austin-photos-2019-10>

¹⁸³ Sterling Archer, "Additive Manufacturing: Potential Solution to the Labor Shortage in Construction," Harvard Business School, 2018. <https://digital.hbs.edu/platform-rctom/submission/additive-manufacturing-potential-solution-to-the-labor-shortage-in-construction/>

¹⁸⁴ "Peri Builds 3D Printed Apartment Building in Germany," Steel Guru, 2020. <https://www.steelguru.com/infrastructure/peri-builds-3d-printed-apartment-building-in-germany>

Despite the promise of AM for certain construction applications, Canada has seen very little commercialization of this technology to date. There are only a handful of small firms working on construction-related AM in Canada, and they are primarily at the R&D stage.^{185,186,187} The main challenge for this AM application in Canada, according to industry insiders interviewed for this study, is communicating the value proposition to a sector that is unfamiliar with the technology and reluctant to invest in the expensive machines that are required.



We thought the industry was at a maturity point, but the reality is that the scale of investment required is much higher. It's even more expensive than metal AM. We have printers that sell for \$1.2 million. It seems like everyone and their grandmother got to the design stage, but there's no money to go any further. And everyone who buys one needs to build a new business case for it. It's not a drag-and-drop ready-made business case. You need to prove the technology to people. We're doing a lot of demonstration prints right now. People have zero exposure to this technology at this point. They literally don't even know what it is. We just print stuff so that people can touch it, feel it, get a bit of a handle on it. One of our competitors is opening workshops, but they cost money. We like to show stuff off for free to get more people in.

– Engineering Manager, Construction, Quebec

- 185** Eva Uguen-Csenge, "New 3D printer can build home in days, says B.C. scientist," *CBC News*, 2019.
<https://www.cbc.ca/news/canada/british-columbia/new-3d-concrete-printer-build-home-days-scientist-1.5111890>
- 186** Jeff Sawyer, "Innovative 3D Concrete Printing Start Up Takes Root in Procter, BC," *The Nelson Daily*, 2020.
<http://thenelsondaily.com/dose/innovative-3d-concrete-printing-start-takes-root-procter-bc>
- 187** "3D Printed Homes Corporation Will Print Houses in as Little as Two Days," *Financial Post*, 2019.
<https://financialpost.com/pmnp/press-releases-pmn/business-wire-news-releases-pmn/3d-printed-homes-corporation-will-print-houses-in-as-little-as-two-days>

The Canadian Additive Manufacturing Landscape

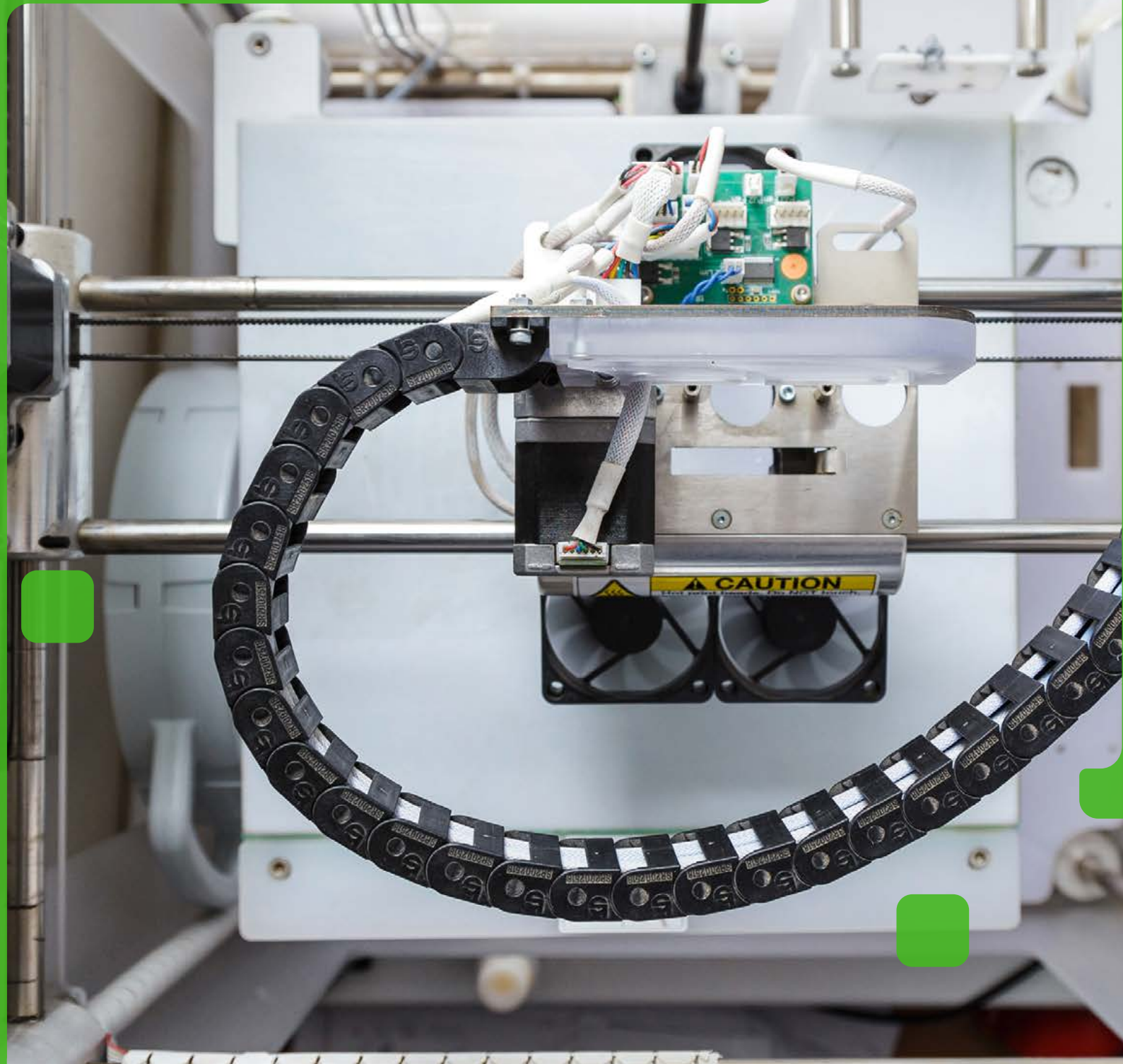

Canada's Place in the Global Additive Manufacturing Ecosystem

Globally, AM is highly centralized in Europe and the US. Europe contains over half (55%) of the world's AM firms, followed by the Americas with 32%, and Asia with 13%. The US is the country with the highest proportion of firms, with 29% of all AM companies, while Germany is second with 24%.¹⁸⁸ The US is by far the dominant player in North America, accounting for 90% of the American AM market, while Germany accounts for a bit less than half of the European market.¹⁸⁹ Collectively, the US and Europe represent five-sixths of the global AM market.

In the last three years, there has been a significant increase in the awareness and the use of AM technologies across different sectors. Globally, the percentage of businesses surveyed by EY that have tried AM technology rose to 65% in 2019 from 24% in 2016.¹⁹⁰ According to the EY Global 3DP Survey, experience with AM technologies was the highest among Asian companies, especially among South Korean (at 88%) and Chinese (at 78%) companies. Canada came third out of 13 countries surveyed.¹⁹¹ Of 47 Canadian companies surveyed, 77% of companies had already applied AM technology, 14% were considering applying it, and only 9% have not considered applying it yet.¹⁹²

Figure 3: Experience of AM Technology, by Country

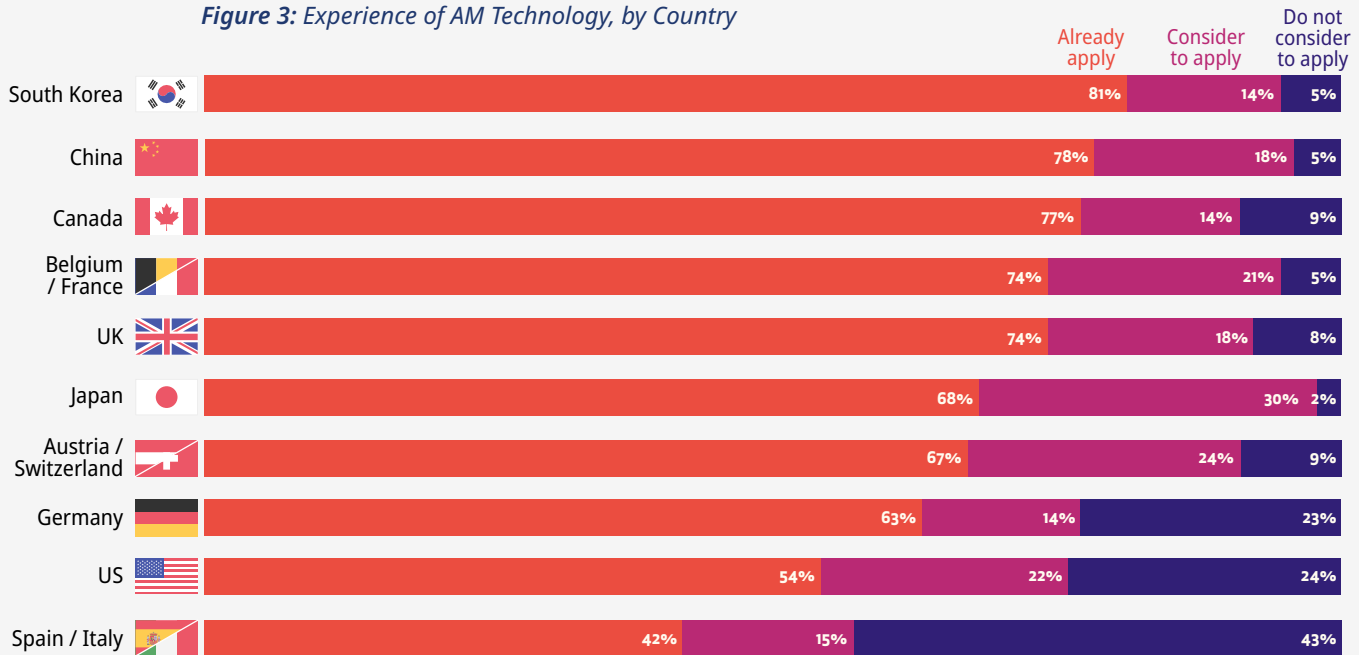

Source: EY Global 3DP Survey, April 2019¹⁹³

¹⁸⁸ Stefana Karevska, Dr. Christoph Kilger, et al. "3D printing: hype or game changer?" EY, 2019. https://assets.ey.com/content/dam/ey-sites/ey-com/en_gl/topics/advisory/ey-3d-printing-game-changer.pdf

¹⁸⁹ Ibid.

¹⁹⁰ Ibid.

¹⁹¹ This may be a result of growth in AM, a decline in traditional manufacturing, or both.

¹⁹² Stefana Karevska, Dr. Christoph Kilger, et al. "3D printing: hype or game changer?" EY, 2019. https://assets.ey.com/content/dam/ey-sites/ey-com/en_gl/topics/advisory/ey-3d-printing-game-changer.pdf

¹⁹³ Ibid.

Canada represents about 2% of the global AM ecosystem,¹⁹⁴ which is relatively small compared to industry leading countries such as the US, Germany, and China. However, the Canadian AM ecosystem is relatively diverse, and in many AM-related areas it possesses a well-integrated value chain (such as in powder manufacturing), strong expertise (in robotics, AI, CAD file management, printer manufacturing), or has seen wide adoption (in aerospace and biomedical). Certain portions of the Canadian AM ecosystem already command a global profile. For example, the province of Quebec is a leader in metal AM research and powder development. Winnipeg's Precision ADM has been Canada's largest manufacturer of 3D-printed medical devices during the COVID-19 pandemic.^{195,196}

While Canada's manufacturing firms have significant experience with AM, study participants also noted that adoption of AM in Canada is widespread but largely superficial. Many have described the Canadian manufacturing sector as conservative, reluctant to try new technologies, and eager to continue with what has worked so far.

Although the Canadian AM ecosystem is small, competition among companies is fierce. While competition is widely considered to be a feature of a vibrant economy, several study participants described the AM ecosystem as combining a) a culture of competition for resources (talent or investment), b) ecosystem fragmentation, and c) requiring major capital investments. Study participants saw this combination of features to be a major obstacle to the growth of the Canadian AM ecosystem. Because AM is a rapidly evolving sector with high costs, value creation often involves substantial investments into research. Once developments that are either cost-saving or value-creating are realized, firms may guard them as a competitive advantage, which will delay their adoption throughout the rest of the sector, and possibly result in the costly duplication of work across companies to develop similar processes. Study participants widely believe that the high costs of adopting AM technology favoured large, established organizations over SMEs.

International competition in the AM ecosystem is intense. Although AM can in theory enable distributed manufacturing, production costs are affected by economies of scale. Large companies possessing 50 to 100 machines enables the completion of large projects in less time and with a lower unit cost than it does for small-scale producers. There are very few places, and none in Canada, where there is enough demand to justify the creation of such large-scale AM "service bureaus" (aka, "print farms") to achieve these cost advantages. Because of the small size of the Canadian market, other key parts of the AM value chain are also underdeveloped relative to the US (such as industry-grade machine manufacturing) or are absent from Canada (such as filament production).

194 "Wohlers Report 2019," Wohlers Associates, 2019. <https://wohlersassociates.com/2019report.htm>

195 "How Precision ADM Became the Largest Producer of 3D Printed Medical Devices," FormLabs, 2020. <https://formlabs.com/blog/precision-adm-3d-printed-medical-devices>

196 "Gatineau plant aiming to produce up to eight million COVID-19 test swabs a month," Ottawa Business Journal, 2020. <https://obj.ca/article/techopia/gatineau-plant-aiming-produce-eight-million-covid-19-test-swabs-month>

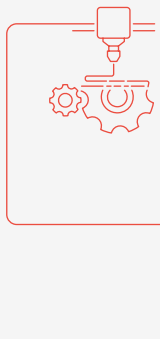

I consider the AM industry [in Canada] to be in its infancy... I think you would be hard-pressed to find 100 additive-focused companies in Canada. Only 20 to 30 of them are on a vaguely industrial level... There are probably less than 1000 people in Canada who are truly knowledgeable about AM.

– Executive, AM Consultancy, Ontario

Initially people thought that AM would make production costs the same anywhere. But this is not the case. There are large economies of scale, such as 50-100 machines. No one can justify putting 50 to 100 million dollars on the table in Canada to create a massive printing centre. The market just isn't there.

– Director, AM Software, Quebec

Supporting Additive Manufacturing in Canada

The Role of Government

Study participants, in general, viewed the federal government as the level of government most relevant in supporting the growth of the AM ecosystem in Canada (the exception to this was in Quebec, where the provincial government was seen as a more important player).

In 2018, the federal government pledged to invest up to \$230M in the Next Generation Manufacturing Supercluster (NGen), “a group of businesses, post-secondary institutions and non-profits working together to make Canada a world leader in advanced manufacturing.”¹⁹⁷ NGen’s objective is to accelerate the development, adoption, and scale-up of world-leading capabilities in Canadian manufacturing.¹⁹⁸ At present, NGen identifies AM as one of its four key focus technologies,¹⁹⁹ and performs a range of functions, including networking companies in advanced manufacturing, providing funding conducting pilot projects, running feasibility studies, building clusters, and bringing technologies to market. Depending on the nature of the project, NGen’s funding capacity ranges from \$50K to \$20M.²⁰⁰ In July of 2020, NGen announced a collaborative funding effort of \$28.8M over nine manufacturing projects, including a consortium to develop AM-based applications to improve the environmental performance of the energy sector. The consortium is led by Exergy Solutions and includes oil giant Suncor Energy and Precision ADM, a leading Canadian AM firm.²⁰¹

¹⁹⁷ “Next Generation Manufacturing Supercluster kicks into high gear,” Innovation, Science, and Economic Development Canada, 2018. <https://www.canada.ca/en/innovation-science-economic-development/news/2018/11/next-generation-manufacturing-supercluster-kicks-into-high-gear.html>

¹⁹⁸ “Advanced Manufacturing Supercluster Five Year Strategy,” nGen, 2020. https://www.ngen.ca/hubfs/Documents/NGenFiveYearStrategy_EN_V1.0.pdf

¹⁹⁹ “Canada’s Next Generation Manufacturing Supercluster,” Innovation, Science, and Economic Development Canada, 2020. <https://www.ic.gc.ca/eic/site/O93.nsf/eng/O0010.html>

²⁰⁰ “Supercluster Projects,” nGen, 2020. <https://www.ngen.ca/supercluster-projects>

²⁰¹ “Canada’s Manufacturing Supercluster and industry partners invest \$28.8 million in new and emerging technologies,” nGen, 2020. <https://f.hubspotusercontent20.net/hubfs/5005023/July%208%20Project%20Announcement/ENG%20FULL%20Supercluster%20Projects%20.pdf>

The federal government also makes investments through the National Research Council of Canada (NRC) into AM research and adoption, with the goal of tackling challenges across various areas of the economy. Within the NRC, the Industrial Research Assistance Program (IRAP) provides a range of advisory services, networking, and financial support for SMEs seeking to grow through research or technology adoption.²⁰² NRC-IRAP includes the Metal Additive Program, which is managed by Canada Makes and provides interested organizations with grants of up to \$5,000 per project to conduct feasibility studies in metal AM, or up to \$10,000 to hire a qualified service provider to design and manufacture a metal AM prototype. Its objective is to help Canadian companies adopt AM by increasing their awareness and de-risking the trial process.²⁰³

The government has also made ambitious investments in certain educational institutions. For example, in November of 2020, it announced an investment of \$2.6 million to help the University of Waterloo purchase equipment to develop and characterize metal AM powders and parts. This collaborative research project between academia and Canada's federal scientists at the NRC aims to identify innovative solutions designed to improve the quality and reduce the costs of feedstock materials used for AM.²⁰⁴ Moreover, the federal government's appeal for COVID-19 aid leveraged AM capabilities in the production of PPE and is viewed as helpful for publicizing the AM industry's importance in producing goods locally. Expanding domestic production is now a government initiative so that Canadian companies are not caught having to source from abroad again should the need arise in the future.²⁰⁵

Study participants credited the government for keeping the AM industry in mind with these actions. They praised NGen and IRAP for incentivising organizations to experiment with AM, even during the COVID-19 pandemic. They said that investing in AM technology and educational programs was crucial to the sector's growth. They also praised the NRC for engaging a large community of researchers in AM. However, study participants seldom mentioned specific programs, and those who did generally felt that these federal programs had made only a modest impact on the growth of AM in Canada. Only a handful of AM entrepreneurs mentioned having dealt directly with NGen or IRAP themselves. The government may consider a strategy to widen the awareness of its programs to support the AM ecosystem.

One opportunity to grow the sector noted by study participants was the development of a national strategy for AM (as has been adopted in several countries, such as the UK²⁰⁶ and the US²⁰⁷). Developing and implementing this strategy was suggested to work best as a joint endeavor between the federal government and industry. Supporters of a focused strategy felt it was necessary to remain competitive with countries that had already adopted such strategies and had advantages in economies of scale. Others preferred the government to focus more on promoting Canada's AM capabilities abroad in the hope of attracting AM-focused investment into the country.

202 "Support for technology innovation," National Research Council Canada, 2020. <https://nrc.canada.ca/en/support-technology-innovation>

203 "NRC-IRAP Metal Additive Program," Canadian Manufacturers and Exporters, 2020. [https://cme-mec.ca/blog/innovation/nrc-irap-metal-additive-program/#:~:text=The%20Metal%20Additive%20Manufacturing%20\(AM,additive%20manufacturing%20\(AM\)%20technology.](https://cme-mec.ca/blog/innovation/nrc-irap-metal-additive-program/#:~:text=The%20Metal%20Additive%20Manufacturing%20(AM,additive%20manufacturing%20(AM)%20technology.)

204 "Government of Canada invests in research collaborations to generate game-changing discoveries," National Research Council Canada, 2020. <https://www.canada.ca/en/national-research-council/news/2020/10/government-of-canada-invests-in-research-collaborations-to-generate-game-changing-discoveries.html>

205 "Ontario helps Manufacturers Ramp Up Production of Personal Protective Equipment," Government of Ontario, 2020. <https://news.ontario.ca/en/release/57091/ontario-helps-manufacturers-ramp-up-production-of-personal-protective-equipment>

206 "UK National Strategy for Additive Manufacturing/ 3D Printing," AM National Strategy, 2021. <http://www.amnationalstrategy.uk/>

207 "Home Page," America Makes, 2021. <https://www.americamakes.us/#:~:text=America%20Makes%20is%20the%20nation's,our%20nation's%20global%20manufacturing%20competitiveness.>

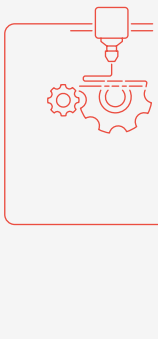

The biggest thing the government can do is work on public perception. Public perception is that 3D is only good for prototyping and can't produce final-use parts. The government can help spread the word that there are more capabilities than that.

– Executive, AM Consultancy, Ontario

Financial incentives and fast-tracking regulation also received a high degree of support from study participants. Regarding financial support, there were many ideas on how to administer funds and to whom those funds should be given. Giving educational institutions grants for the purchase of AM equipment and the development of programs was one of the most popular suggestions. Some suggested increasing the funds available to organizations via NGen and NRC-IRAP as well as streamlining the process to acquire these funds and promoting these programs. In some sectors (particularly aerospace, automotive, and construction) participants believed that the integration of AM can be expedited via regulatory frameworks to enable more use cases.



So there are business development NRC-IRAP programs. They exist, but I think some companies need a bigger push to use them. I wish there was more of a community in AM in Canada. I wish there was more exposure for AM, as in trade shows. We need more companies exposed to the technology.

– Program, Aerospace, Atlantic Canada

I think we need to have a global strategy for the country to move forward together to collaborate. If we just say we need more equipment, we can spend a lot of cash just buying equipment, and I think some students will have access to that. But at the end of the day, what will be the outcome? Running that equipment is so expensive that you cannot just have the students working on it and doing nothing with it. We need to have a strategy to make the most of each single dollar that the country will spend on that. Because the competition has more resources, more researchers, more cash, and more equipment

– Program, Aerospace, Atlantic Canada



The Role of Educational Institutions

A large network of education and research institutions are available for those interested in AM. In general, participants praised Canada's educational institutions for creating intelligent, adaptive students who are hard-working and eager to embrace technologies. There was a general degree of satisfaction expressed with the quality of graduate-level programs and the talent they produce. Moreover, study participants from educational institutions generally agreed that the demand for AM courses was growing, that AM had become increasingly visible at universities, and that educational institutions were seeking to grow their involvement with the technology.



We have 20–30 students from different programs in every semester (60–90 a year). Some students in materials science take the [AM] course. It gives the fundamental engineering basics in AM as well as hands-on experience and industrial insights. The course attracts people. Demand is growing. We offered it only twice last year, now we're offering it three times a year.

– Postdoctoral Fellow, Education, Ontario

Participants generally agreed that educational institutions offered good opportunities to be exposed to AM. By the end of 2020, there were labs with AM equipment in at least one post-secondary institution in each Canadian province.

Table 2: Post-Secondary Institutions Offering AM Resources or Instruction

British Columbia

- University of British Columbia²⁰⁸
- Simon Fraser University²⁰⁹
- Emily Carr University of Art + Design²¹⁰
- Camosun College²¹¹

Alberta

- University of Alberta²¹²
- University of Calgary²¹³
- Southern Alberta Institute of Technology²¹⁴
- Northern Alberta Institute of Technology²¹⁵

Saskatchewan

- University of Saskatchewan²¹⁶

Manitoba

- University of Manitoba²¹⁷

Ontario

- University of Toronto²¹⁸
- University of Waterloo²¹⁹
- Ryerson University^{220,221}
- University of Guelph²²²
- McMaster University²²³
- York University²²⁴
- University of Windsor²²⁵
- Carleton University²²⁶
- University of Ottawa²²⁷

- Sheridan college²²⁸
- University of Western Ontario²²⁹
- Mohawk College²³⁰
- Conestoga College²³¹
- St. Clair College²³²
- Ontario Tech University²³³

Quebec

- McGill University²³⁴
- Université de Laval²³⁵
- Polytechnique Montreal²³⁶
- Université de Montreal²³⁷

New Brunswick

- University of New Brunswick²³⁹
- New Brunswick Community College²⁴⁰

Prince Edward Island

- University of Prince Edward Island^{241,242}

Nova Scotia

- Dalhousie University²⁴³
- Nova Scotia Community College²⁴⁴

Newfoundland and Labrador

- Memorial University Newfoundland²⁴⁵

208 Tess Boissonneault, "UBC becomes first Canadian university to install GE Additive EBM Q20plus 3D printer," 3D Printing Media Network, 2019. <https://www.3dprintingmedia.network/ubc-canadian-install-ge-additive-q20plus-3d-printer/>

209 "SFU Additive Manufacturing Library," Simon Fraser University, 2020. http://www.sfu.ca/~woosook/About_PI.html

210 "Material Matters," Emily Carr University of Art + Design, 2020. <https://research.ecuad.ca/materialmatters/>

211 "Camosun Innovates Face Shield Design Files," Camosun College, 2020. <http://camosun.ca/innovates/>

212 "Laboratory of Intelligent Manufacturing, Design, and Automation (LIMDA)," University of Alberta, 2020. <https://sites.ualberta.ca/~rafiq1/aboutus.html>

213 "Overview," University of Calgary Laboratory of Engineering Materials, 2020.

<https://live-ucalgary.ucalgary.ca/labs/engineering-materials/engineering-materials>

214 "Our Services," Southern Alberta Institute of Technology, 2020. <https://www.sait.ca/research-and-innovation/our-services>

215 "Makerspace," Northern Alberta Institute of Technology, 2020. <https://student.nait.ca/student-services/academic-experience/library-services/makerspace>

216 "USask engineering team designing 3D-printed N95 masks to help combat COVID-19," University of Saskatchewan, 2020. <https://news.usask.ca/articles/research/2020/usask-engineering-team-designing-3d-printed-n95-masks-to-help-combat-covid-19.php>

- 217 "3D Printing/3D Scanning," University of Manitoba, 2020. <http://umanitoba.ca/faculties/architecture/fablab/3DPrinting3Dscanning.html>
- 218 "Our Research," Toronto Institute for Advanced Manufacturing, 2020. <https://tiam.engineering.utoronto.ca/research/>
- 219 "Additive Manufacturing Research," University of Waterloo, 2020. <https://uwaterloo.ca/additive-manufacturing-research/>
- 220 "Research," Ryerson University Mechanical and Industrial Engineering, 2020. <https://www.ryerson.ca/mechanical-industrial/research/>
- 221 "Ryerson University – Advanced Manufacturing," Universities Canada, 2020. <https://www.univcan.ca/universities/university-industry-research-partnerships/ryerson-university-advanced-manufacturing/>
- 222 "Advanced Manufacturing Lab," University of Guelph, 2020. <https://www.uoguelph.ca/engineering/ideiab/home>
- 223 "Additive Manufacturing Group," McMaster University, 2020. <https://www.eng.mcmaster.ca/sept/practice/amg>
- 224 "New program will prepare students to develop specialized 3D printing technologies for industry," York University, 2020. <https://yfile.news.yorku.ca/2020/06/03/new-program-will-prepare-students-to-develop-specialized-3d-printing-technologies-for-industry/>
- 225 "Advanced Production and Design Lab," University of Windsor, 2020. <https://www.uwindsor.ca/engineering/research/382/advanced-production-and-design-lab>
- 226 "Advanced Manufacturing Labl," Carleton University, 2020. <https://carleton.ca/aml/>
- 227 "uOttawa Richard L'Abbé Makerspace," uOttawa, 2020. <https://engineering.uottawa.ca/ceed/design-spaces/makerspace>
- 228 "Centre for Advanced Manufacturing and Design Technologies (CAMDT)," Sheridan College, 2020. <https://www.sheridancollege.ca/research/active-research/camdt>
- 229 "Western University," Ontario Advanced Manufacturing Consortium, 2020. <https://www.amconsortiumontario.ca/capabilities/western-university/>
- 230 "Additive Manufacturing and 3D Printing," Mohawk Continuing Education, 2020. <https://www.mohawkcollege.ca/ce/programs/technology-and-skills/additive-manufacturing-and-3d-printing>
- 231 "Conestoga opens new Centre for Smart Manufacturing," Academica Group, 2015. <https://www.academica.ca/top-ten/conestoga-opens-new-centre-smart-manufacturing>
- 232 "Solution for Startup Discovered Through Applied Research's 3D Printer," St. Clair College, 2019. <https://www.stclaircollege.ca/news/2019/solution-startup-discovered-through-applied-researchs-3d-printer>
- 233 "Research - Manufacturing," Ontario Tech University, 2020. <https://nuclear.ontariotechu.ca/piro/research/manufacturing.php>
- 234 "Welcome to the Additive Design and Manufacturing Lab," Additive Design and Manufacturing Lab, 2020. <https://adml.lab.mcgill.ca/>
- 235 "GML-3010 Matériaux pour la fabrication additive," Université Laval, 2020. <https://www.ulaval.ca/les-etudes/cours/repertoire/detailsCours/gml-3010-materiaux-pour-la-fabrication-additive.html>
- 236 "Infrastructure de fabrication additive," Polytechnique Montréal, 2020. <https://www.polymtl.ca/lm2/visites-virtuelles-du-laboratoire/infrastructure-de-fabrication-additive>
- 237 Martin Lasalle, "De Disney Research à l'UdeM: le parcours enchanté de Bernhard Thomaszewski," Udem Nouvelles, 2018. <https://nouvelles.umontreal.ca/article/2018/04/19/de-disney-research-a-l-udem-le-parcours-enchante-de-bernhard-thomaszewski/>
- 238 "MEC627 Technologies de fabrication additive," École de Technologie Supérieure, 2020. <https://www.etsmtl.ca/etudes/cours/MEC627>
- 239 "About the Marine Additive Manufacturing Centre of Excellence," University of New Brunswick, 2020. <https://www.unb.ca/mamce/>
- 240 "3D Printing Technology and Applications," New Brunswick Community College, 2020. <https://nbcc.ca/applied-research/research-projects/3d-printing-technology-and-applications>
- 241 "3D Printing," University of Prince Edward Island – Robertson Library, 2020. <https://library.upei.ca/3dprinting>
- 242 "Facilities," University of Prince Edward Island – Sustainable Design Engineering, 2020. <https://www.upei.ca/programs/engineering/facilities>
- 243 "Advanced Manufacturing Hub," Dalhousie University, 2020. <https://www.dal.ca/faculty/engineering/idea-project/advanced-manufacturing-hub.html>
- 244 "Renishaw helps develop ocean turbine parts using metal Additive Manufacturing," Metal AM, 2020. <https://www.metal-am.com/renishaw-helps-develop-ocean-turbine-parts-using-metal-additive-manufacturing/>
- 245 Jeff Green, "Passionate researchers use 3D printing technology to advance health care," Memorial University News, 2018. <https://www.mun.ca/research/news.php?id=11679&type=news>

Getting Equipment into Schools

Significant technological advancements over the last 20 years have lowered the price of 3D printers considerably and has allowed for wide-scale adoption by schools, libraries, SMEs, and individuals. Primary education institutions across Canada have already embraced AM's potential for K-12 students and continue to invest in AM technologies. Moreover, manufacturing companies such as General Electric (GE) are helping to equip schools with 3D printing equipment and providing access to AM technology and the curriculum to support the AM learning. The Global GE Additive Education Program delivers polymer 3D printer packages to primary and secondary schools and metal 3D printers to colleges and universities.²⁴⁶ Each package includes hardware, software and Science, Technology, Engineering, Art, and Mathematics (STEAM) curriculum. The program aims to accelerate awareness and education of 3D printing among students and has an objective of building a pipeline of talent that understands 3D design and printing.²⁴⁷ As of 2020, almost every school in Canada has at least one 3D printer.²⁴⁸ Several Canadian organizations, such as Tinkerine, focus on manufacturing 3D printers for primary and secondary education institutions as well as providing associated services such as curriculum development.²⁴⁹ To overcome difficulties at facilitating adoption of the technology at schools, such as reticence among teachers who are unfamiliar with the technology, Tinkerine offers special learning package to aid parents, students, and teachers with 3D printing learning activities to engage and educate K-12.²⁵⁰



We provide students and teachers with access to 3D printers, and design challenges. These get the students to think about basic principles of engineering. They can later apply design principles. 3D is positioned as a tool in this process. We co-develop curriculum with technology-specific teachers, focusing on applied design skills and technology. Our printers are used throughout K-12 across BC. We are also in Alberta, Quebec, and Ontario. Schools have equipped their entire labs with our products. One interesting challenge we saw was not the access to technology. We saw that there were lots of educators who were uncomfortable with it at first. Around 75% of teachers and librarians did not even know how to start tackling the technology. Even if it was in their classroom, they weren't comfortable using it. Transferring the knowledgebase to the teachers was a key step. We now have modules online for teachers.

– Executive, Original Equipment Manufacturer, British Columbia

²⁴⁶ "GE Additive Education Program open for entries from primary and secondary schools," GE Additive, March, 2019. <https://www.ge.com/additive/press-releases/ge-additive-education-program-open-entries-primary-and-secondary-schools>

²⁴⁷ Ibid.

²⁴⁸ Tyler Fleming "Ottawa school board uses 3D printers to help make supplies for frontline workers," CTV News, 2020. <https://ottawa.ctvnews.ca/ottawa-school-board-uses-3d-printers-to-help-make-supplies-for-frontline-workers-1.4905714>

²⁴⁹ "Our Vision," Tinkerine, 2020. <https://www.tinkerine.com/about>

²⁵⁰ "Tinkerine Studios offers "Design at Home" to assist parents, students & teachers during COVID-19 crisis," Canadian Insider, 2020. <https://www.canadianinsider.com/tinkerine-studios-offers-design-at-home-to-assist-parents-students-teachers-during-covid-19-crisis>

However, despite these advancements, study participants felt there were numerous areas of the current AM education system that could be improved. Some characterized the supply of AM equipment at universities or colleges as being “barebones,” lacking in both quantity and variety. Educational institutions were occasionally criticized for giving students insufficient access to AM equipment.



Our educational facilities have a significant lack of equipment. I've been working with a couple of universities and colleges in southwestern Ontario here that have less hardware than some people have in their living room. How are these students supposed to train if they don't even have the most basic equipment?

– Executive, AM Consultancy, Ontario

Some schools have fancy equipment, but it's reserved for professors doing research.

– AM Consultant, Freelance, British Columbia

Starting AM Education Early

Participants consider the educational programs in AM as limited in scope, even at “leading” post-secondary educational institutions, which they saw as more focused on research. For example, McMaster University, while described as one of the leading post-secondary institutions in AM research by study participants, offers a single AM course to graduate-level engineering students and has no courses available in AM at the Bachelor's level.



Unfortunately, we don't have a strong program in any Canadian university. We have some courses here and there. McMaster, for example, does a ton of research but only has one course.

– Postdoctoral Fellow, Education, Ontario

Exposure to AM technologies for undergraduate students was seen by study participants as superficial, involving a class or two or a capstone module “tacked on” at the end of the degree or certificate program. Participants felt that such programs provided exposure, as opposed to skills, and were not sufficient on their own to develop work-ready AM professionals. Many participants stressed the need for AM to be integrated more systematically into the curricula of manufacturing programs. At the same time, they acknowledged that AM is a dynamic field involving many different processes and materials, and thus it was unrealistic to expect a vocational program to give students all the necessary preparation for work in AM.

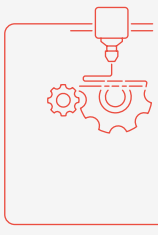

AM is not a speciality at this point. No one comes out with a degree in AM. Can it be part of the syllabus? Yes, it can be integrated, and I see more and more professors integrating AM into the requirements of their degree. But I know that the CEGEP [Quebec's first level of post-secondary education] is not handling it in depth; they'll do one session on it in the course of a whole program.

– Engineer, Aerospace, Quebec

Students cannot come out of college or university being 100% ready. There's just not enough time to develop that skillset and still have a well-rounded education. But I'll tell you what doesn't work—I've been doing capstone design projects for mechanical and materials engineering in the undergraduate level for quite a few years now. And even if you put "must use additive manufacturing as a tool" in the design problem, they cannot do this. They don't have the tools to be able to think that way. They don't understand the metallurgy. They don't understand design. So, even if you force them to have to do this at the fourth-year level, they are not capable of it. So, these tools need to be integrated throughout the program and not just consigned to a structured design project. They cannot comprehend it at that one junction in time.

– Manager, Education, Alberta

As the Canadian workforce becomes more educated,²⁵¹ some study participants raised concern about the disproportionately high number of PhD's, Master students, and postdoctoral scholars being produced by the educational system who were difficult to integrate into the workforce. Specifically, study participants saw such educated talent as being overqualified, too specialized, too expensive, or not practical enough for many roles available within the Canadian AM industry. Study participants mentioned that the industry, in particular metal AM, is lacking skilled tradespeople like technicians, technologist, machine operators, etc. Organizations had various ways of dealing with the relative mismatch between workforce needs and the available skills. Some noted that AM graduates with a PhD are being employed as technicians, and some PhD's are offering to do free internships.



I'd love to hire a PhD, and about 10 of them a week show up with resumes trying to get a free internship here, which I actually don't offer because we're a very small operation.

– Program, Aerospace, Atlantic Canada

Hiring a PhD or somebody in their postdoc level is not very appealing at the moment for additive manufacturing design and running machines because you can simply train a technician with design expertise, and they can do the job properly.

– Professor, Education, Atlantic Canada

²⁵¹ "Education in Canada: Key results from the 2016 Census," Statistics Canada, 2016. <https://www150.statcan.gc.ca/n1/daily-quotidien/171129/dq171129a-eng.htm>

When asked how the educational system in Canada could improve, participants voiced a wide range of opinions. Regarding AM programs, participants generally advocated increasing the variety and availability of AM coursework in educational institutions. As well, study participants stressed the importance of hands-on experience with printers and that increasing the quantity, variety, and access of AM equipment in educational institutions should be a key priority at all levels of the educational system. Participants also suggested that educational institutions increase internships, co-op placements, apprenticeships, upskilling and career-transition programs, which are important to growing AM talent. Increasing training opportunities for technicians to operate AM systems was considered a particularly urgent priority, given the shortage of talent in this area. Germany was referenced by several participants as a country with vocational educational programs worth emulating.

Canada's AM Firms

Interviewees noted that the majority of Canadian companies involved in AM are small businesses, which reflects the structure of the wider Canadian economy.²⁵² Although there are no exact statistics on the number of AM-focused companies in Canada, Tracxn, a global online platform for tracking innovative companies across tech sectors worldwide, estimates there were 64 AM startups in Canada in April 2020.²⁵³

Study participants felt that Canadian companies involved in AM show a great deal of diversity, with the potential to encompass a wide range of business models and serve a variety of sectors. The Canadian AM industry is represented by original equipment manufacturers (OEMs), printing farms, value-added resellers (VARs), and other business models. The AM industry also includes software companies selling simulation tools or software for AM machines. Most all AM-focused organizations in Canada also have at least three or four separate revenue streams. Services which are commonly combined include re-selling printers, customizing printers, operating a print form, offering training sessions, and offering prototyping or design consultation services.

Table 3: Types of companies involved in AM in Canada

BUSINESS TYPE	ABOUT	EXAMPLES
Original Equipment Manufacturers (OEMs)	Produce and sell 3D printers, hardware and/or software to VARs or industrial clients Domestic OEMs are relatively rare in Canada Vary greatly in size from medium to very large ("very large" usually being multinational companies from the US)	AON3D Tinkerine Nanogrande Augmenta AI MayaHTT EOS (Intl) Renishaw (Intl)

²⁵² "Key Small Business Statistics – January 2019," Innovation, Science and Economic Development Canada, 2019. https://www.ic.gc.ca/eic/site/061.nsf/eng/h_03090.html

²⁵³ "3D Printing Startups in Canada," Tracxn, 2020. <https://tracxn.com/explore/3D-Printing-Startups-in-Canada>

BUSINESS TYPE	ABOUT	EXAMPLES
<p>Printing Farms (aka Service Bureaus, Print Shops)</p>	<p>Provide printing facilities and AM experts for interested organizations or individuals to go from a CAD design to a high-quality finished print</p> <p>Canadian ones are usually smaller in capabilities compared to the largest service bureaus in the US</p>	<p>Burloak Technologies FusiA (Intl) Solaxis Voestalpine (Intl) Promation, Exergy Solutions Nova Product Development Proto3000 Anubis 3D Industrial Solutions Axis Prototypes Objex Unlimited Javelin Technologies</p>
<p>Value-Added Resellers (VARs)</p>	<p>Sell AM-related products, including hardware (sometimes including customized printers) and software to end-users</p> <p>May provide value-added services, such as classes on how to use printers or in CAD design</p> <p>May offer experience centres where people can see the technology up close</p> <p>May combine Additive-related services with other Advanced Manufacturing Technologies</p> <p>May offer small-scale print farm capabilities</p>	<p>CAD MicroSolutions DesignFusion Wave of the Future 3D</p>
<p>AM Consultancy</p>	<p>Often Small-scale engineering firms in which the consultant, usually an expert with many years of experience in AM, helps organizations to incorporate AM into their workflow to enhance productivity and bottom line; also, popularizing the benefits of AM technology</p> <p>Other times, a service bureau will perform this function</p> <p>Consulting may include taking the client from the design stage (assuming they didn't know how to use Solidworks or CAD software) to the completed product</p> <p>Receive bulk of revenue from Rapid Prototyping and design services</p>	<p>Island Additive 3D Additive Fabrication Precision ADM Exergy Solutions</p>

BUSINESS TYPE	ABOUT	EXAMPLES
Artisanal AM Entrepreneurs	<p>Small-scale manufacturers who specialize in an artisanal model of business, often using AM as a way to make extra money as a hobby</p> <p>This business model overlaps or transitions to that of an AM consultant</p>	<p>Island Additive 3D Additive Fabrication</p>
Printing Startups	<p>Business model often lies somewhere between the service bureau and VAR. Earns revenue selling both printers and products to clients</p> <p>Typically, small in scale and heavily focused on a cutting-edge application of 3D printing, whether to a specific sector (such as architecture) or a specific AM application (such as bioprinting, digital manufacturing or high-quantity AM)</p>	<p>Twente Additive Manufacturing 3DQue Pep Corp Aspect Biosystems</p>
Industrial Adopters	<p>Established organizations apply existing AM technology to improve their business model or that of their clients'</p> <p>Due to their size and establishment in industry, they are significant contributors to the development of standards and IP</p> <p>Of all players in AM, are best able to mobilize capital investments toward adoption of new technologies</p> <p>In Canada, usually focused on Aerospace, Tooling, Engineering, or Automation</p> <p>Within organizations, AM professionals usually represents a small percentage of total workforce</p>	<p>Bell Textron (Intl) Pratt & Whitney (Intl) MDS Coating Technologies ATS Automation Liburdi Automation Tronosjet Advantage Engineering HP (Intl)</p>
Raw Materials Producers	<p>Produce raw materials used in AM processes</p> <p>In Canada, generally clustered in Quebec and focused on powder production for metal AM</p> <p>Often acquired by international firms</p>	<p>Tekna (Intl) GE Advanced Powders & Coatings (Intl) RioTinto (Intl) Equispheres Pyrogenesis</p>

Source: ICTC, 2020

Canada's Strengths in AM

When asked holistically about Canada's advantages in the field of AM, study participants presented a wide variety of opinions, ranging from Canada possessing numerous advantages in AM to none at all. Many study participants praised Canada's AM metal powder industry, which is highly active in Quebec and involves major international firms, including GE. Medical AM was also highlighted as an area of significant achievement and high growth potential, which has benefited from high engagement from universities and industry. For example, Western University and Renishaw PLC announced in 2017 a \$6.8 million partnership to establish Additive Design in Surgical Solutions (ADEISS), a new research, development, and commercialization centre focused on medical AM.²⁵⁴

The government was praised for certain programs, such as NRC's IRAP, which employs a large staff of AM researchers and has made innovations in a laser-consolidation process that allows for metal components to be produced without the need for machining surfaces.²⁵⁵ After successfully testing and prototyping the laser-consolidation technology, it was licensed to Oakville-based Burloak Technologies, a global leader in AM.²⁵⁶ The NRC's IRAP²⁵⁷ was also praised for doing laudable work in promoting the sector and securing funding for deserving organizations.

Challenges for Canadian AM

While study participants generally voiced optimism regarding the future of AM in Canada, they identified numerous challenges facing the growth of the domestic AM ecosystem. These difficulties were diverse in nature, encompassing structural features of the industry itself, challenging AM market trends, competition with and dependence on foreign countries, and idiosyncratic characteristics of Canadian business culture and institutions. Study participants generally saw Canada as being behind its competitors in Europe, Asia, or the US when it comes to adopting AM technologies. Several participants described AM adoption in Canada as "a decade behind the US and Europe."

Risk Tolerance

Study participants described Canadian organizations as showing a lot of interest in AM and a willingness to adopt it for certain superficial use cases (such as prototyping). However, they felt that there was a slow rate of adoption for more cost-intensive use cases.²⁵⁸

²⁵⁴ "London to become North American leader in 3D printing for medical and surgical solutions," *University of Western Ontario Media Relations*, 2017. <https://mediarelations.uwo.ca/2017/04/21/london-become-north-american-leader-3d-printing-medical-surgical-solutions/>

²⁵⁵ "Laser-sharp innovation: NRC researchers take additive manufacturing to the next level," *National Research Council Canada*, 2020. <https://nrc.canada.ca/en/stories/laser-sharp-innovation-nrc-researchers-take-additive-manufacturing-next-level>

²⁵⁶ *Ibid.*

²⁵⁷ "Support for Technology Innovation," *National Research Council Canada*, 2020. <https://nrc.canada.ca/en/support-technology-innovation>

²⁵⁸ Grant Cameron, "Adopting additive: the benefits of 3D printing for small manufacturers," *Manufacturing Automation*, 2020. <https://www.automationmag.com/adopting-additive-the-benefits-of-3d-printing-for-small-manufacturers/>

Several participants attributed this slow adoption to a risk-averse business culture in Canada relative to the US, which they found particularly noticeable among manufacturing organizations, financial institutions, and investors. These interviewees saw Canadian firms as having an attitude of “wait and see,” not wanting to invest too much in the technology until they had seen another firm do so successfully. This risk aversion was seen as particularly acute in metal AM, where equipment is invariably expensive and use cases are frequently in the aerospace and automotive sectors (and where the challenges of anisotropy and variable part quantity may be particularly difficult to overcome). Participants felt that a low number of successful, publicized use cases had decision-makers reluctant to try the technology.

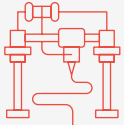

There's a lack of projects that have the visibility that get people to want to adopt additive: they think it's this new, novel trinket thing or they don't really see how it can transform their business. And so, we need those case studies that are showing what additive can do with real examples. We need to see the actual parts. But we also need people out there selling, telling people about this because the industry knowledge in [my sector] is very low. They think it's just the plasticky trinket-type Yoda heads that everyone's seen on the internet. But really, we're able to recreate metal parts that can go into functioning machines.

– Engineer, Energy, Alberta

Difficulties in Quality Control, Certification, and Standardization

As discussed earlier in this report, the joint technical committee²⁵⁹ of the International Organization for Standardization (ISO) and ASTM International has currently published 19 international standards.²⁶⁰ These are, however, primarily focused on general AM principles and part design. While there are a further 28 standards currently under development,²⁶¹ boosting AM adoption and investment among a broader user base will require an increase in globally accepted industrial standards focused on product testing, quality assurance, and qualification.

Study participants identified the *inability to rapidly certify AM parts* as a major barrier hampering widespread adoption of AM worldwide, particularly in Canada. Certification issues were seen to favour the largest organizations in the largest AM markets, whereas small companies typically find quality testing of parts prohibitively expensive.



The ultimate problem is the certification. We need to prove the parts we are using actually work. There are so many variations in materials and processes in metal AM. Typically, in aerospace, all parts are tested using ultrasound, X-rays, magnetic particle inspection, etc., but none of these techniques are suitable for AM.

– Engineer, Aerospace, Quebec

²⁵⁹ “ISO/TC 261 – Chairman Statement,” ISO, 2021. <https://committee.iso.org/home/tc261>

²⁶⁰ “Standards by ISO/TC 261: Published standards,” ISO, 2021. <https://www.iso.org/committee/629086/x/catalogue/p/1/u/0/w/0/d/0>

²⁶¹ “Standards by ISO/TC 261: Standards under development,” ISO, 2021. <https://www.iso.org/committee/629086/x/catalogue/p/0/u/1/w/0/d/0>

Ecosystem Fragmentation

Interviewees highlighted *fragmentation and lack of communication between key players in the AM industry* as a major weakness of the ecosystem in Canada. This fragmentation was described as being both geographic (East vs. West), linguistic (French and English Canada), and between different groups of stakeholders (academia, industry, and government). Among participants, many were unable to mention more than two or three Canadian organizations (besides their own) focused on AM. Awareness of specific research activities in AM at universities is also low. Many participants felt that those involved in the industry are not collaborating as much as would be ideal, and this is potentially resulting in inefficiencies and duplication of work. They also felt that this fragmentation had made the Canadian AM ecosystem oblivious to its own successes and was in part to blame for misconceptions about the technology as well as lower rates of adoption.

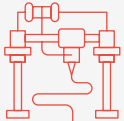

My main sources of information about Canadian AM achievements are the US conferences and international AM experts. They seem to be better informed about Canadian AM brilliance than most Canadians.

– Member, AM Association, Ontario

We are a part of the Holistic Innovation and AM network. It includes, I believe, more than five major universities in Canada. We have laboratories, which have very high-tech machines, a very diverse range of different types of AM technology from electron beam powder bed to laser, different types of selective laser melting and different types of polymers, ceramics and composites. I believe what is lacking here maybe is communication. We need just to create that link to let everyone know that we do have such facilities in Canada, but maybe not everyone is aware of it.

– Program Director, Education, British Columbia

Small and Supply Chain Beholden Ecosystem

Canada's AM ecosystem was frequently compared by study participants to the US and was often highlighted as being relatively small and highly dependent on the US (and to a lesser extent on Europe and China). Canada was seen to be dependent on foreign supply chains for a wide range of AM goods and services, including printers, spare parts for printers, technical consultation related to printers (such as set-up and maintenance), and polymer producers. Some participants felt that the dependency of Canada's AM ecosystem on foreign supply chains is one of its biggest weaknesses, and this weakness was brought into sharp focus by the COVID-19 pandemic.



One thing that is limiting is that we don't have a local manufacturing base for AM machines in Canada. There are some machines made in Canada, FDM machines in particular. But most are made outside of Canada. That leads to small companies paying high import duty taxes on new machines. Secondly, I have used machines that went down, and we had to wait for weeks because there was just one company in all of Canada providing service on these machines. Those are some of the biggest hurdles.

- 3D Printing Specialist, Engineering, Ontario

The biggest effect on supply lines was from China. Our resin printers and related supplies are made in China. When the pandemic hit, all the facilities were closed. You couldn't get resin or printers or spare parts. We had to improvise solutions to that with local suppliers because we couldn't order stuff.

- Manager, Value-Added Reseller, Saskatchewan

Supply chains in AM became tricky because we're so far down on the purchasing power list. If you are making those face shields, you could not find that sheeting of acrylic anywhere. It is all from China, and as soon as you ordered it and it landed in Seattle, it was gone to the States. You didn't get to see a cent of it. We don't have service centres in Canada. We don't have manufacturing of large equipment in Canada. We don't have polymer extruders in Canada.

- Manager, Education, Alberta



Case Study

Additive Manufacturing in Germany

Canada's neighbour to the south, the US, shares a dominant position along with Germany in the AM ecosystem. Germany manages to compete effectively with the US in AM despite its economy only being a fifth of the size of America's. For Canada to effectively compete in the global AM ecosystem, a number of policies similar to Germany's may be considered.

Germany's AM Ecosystem

Germany is recognized widely as one of the top AM markets in the world and competes vigorously with the much more populous USA. In 2019, the German 3D printing market was estimated as the largest in the world at US \$1.28 billion, narrowly surpassing the US market at US \$1.23 billion. By contrast, Canada's AM market was estimated at US \$236.2 million on the same list and ranked 13th, behind Turkey and ahead of Russia.^{262,263} Germany was the source of 19.1% of all patent applications in AM from 2010 to 2018, surpassed only by the US.²⁶⁴ Of the 20 organizations that submitted the most patents for AM at the European Patent Office, 11 were American and five were German.²⁶⁵ Germany's AM ecosystem is rated as one of the best in the world. Kearney, a management consulting firm, rated Germany's AM ecosystem as second best in the world after the USA's based on six metrics. The study also noted that Germany was challenging the US, which was in danger of losing its top spot.²⁶⁶

The German AM ecosystem is highly diversified and includes some of the largest global OEMs in AM, including EOS, Kolb, and BASF 3D Printing Solutions.²⁶⁷ Organizations outside Germany have long recognized Germany's dominance in AM, with some establishing AM operations in Germany or buying positions in German firms. General Electric (GE) established its first AM centre in Germany in 2019,²⁶⁸ after acquiring a 75% stake in Concept Laser (a maker of Laser-based AM machines) in 2016.²⁶⁹ Not only is Germany's domestic base of AM-focused organizations very strong, but AM penetration is high throughout the wider manufacturing industry in Germany; a 2018 study by Bitkom found that 27% of German industrial manufacturing companies were using AM, 8% higher than two years prior.

²⁶² Pawel Slusarczyk, "Top 20 countries investing the most in additive technologies," 3D printing Centre, 2020. <https://3dprintingcenter.net/top-20-countries-investing-the-most-in-additive-technologies/>

²⁶³ "2019 Additive Manufacturing Market Growth Surpassed \$10B Worldwide," SmarTech Analysis, 2020. <https://www.smartechanalysis.com/news/2019-additive-manufacturing-market-growth/>

²⁶⁴ Maija Palmer, "Europe's 3D printing industry booms," Sifted, 2020. <https://sifted.eu/articles/europes-3d-printing-boom/>

²⁶⁵ Ibid.

²⁶⁶ "3D printing: disrupting the '12 trillion [sic] manufacturing sector," Kearney, 2020. <https://www.de.kearney.com/operations-performance-transformation/article?/a/3d-printing-disrupting-the-12-trillion-manufacturing-sector>

²⁶⁷ Carolin Werthmann, "Additive Fertigung in Deutschland – 5 Firmen, von denen man gehört haben sollte," Redshift, 2020. <https://redshift.autodesk.de/3d-druck-deutschland/>

²⁶⁸ "GE Additive inaugurates new facility in Germany," GE, 2019. <https://www.ge.com/additive/press-releases/ge-additive-inaugurates-new-facility-germany>

²⁶⁹ "GE Reaches Agreement to Acquire a 75% Stake in Concept Laser GmbH of Germany," Business Wire, 2016. <https://www.businesswire.com/news/home/20161026007070/en/GE-Reaches-Agreement-to-Acquire-a-75-Stake-in-Concept-Laser-GmbH-of-Germany>



Case Study: Additive Manufacturing in Germany

Furthermore, 14% of the respondents were not using AM, but planned to use it in the future. AM was one of the most widely used cutting-edge technologies among German industrial companies, surpassed only by cloud computing, “Industry 4.0 applications,” and big data analytics. Organizations used AM for a wide range of functions, including making moulds or tools (34% of users), spare parts (32%), visual models (23%), functional models (12%), and assembly devices or custom-made products (8%).²⁷⁰ The COVID-19 pandemic has further facilitated the growth of industrial AM in Germany; a 2020 survey of German decision-makers in design, production, and technology found that 86% planned to increase their investments in AM, and 43% of them were directly motivated to do so by problems related to COVID-19 (such as supply chain problems, business losses, cost hikes, and delays).²⁷¹

The Roots of German Success in AM

Germany's success in AM involves a range of intersecting factors, including actions by industry, government, and enterprises as well as an underlying culture of innovation and openness to technology.

Government Involvement

Actions by government at all levels have supported the growth of the AM ecosystem in Germany. The German federal government coined the phrase *Industrie 4.0* in 2011 and made a commitment to invest in advanced manufacturing technologies.²⁷² Annual investments began after the plan was finalized in 2013, growing from 320 million euros in 2013 to 2.6 billion euro in 2020.²⁷³ Some of this funding goes to the federal government's *Digital Jetzt*²⁷⁴ (Digital Now) program, which allows grants of up to 65% of the total cost of purchasing a 3D printer (to a maximum of 50,000 euros for a single printer, and up to 100,000 euros for an AM-based value chain). These grants are renewable and restricted to SMEs.²⁷⁵

While the German federal government manages the lion's share of funding in Industry 4.0 directly, other levels of government in Germany have specifically promoted investment in Industry 4.0. The state of Saxony-Anhalt, for example, has identified AM as a key Industry 4.0 technology for its future and promotes local AM ecosystem achievements.²⁷⁶ The State of Baden-Württemberg helps SMEs to digitize their operations with funding ranging up to 120,000 euros.²⁷⁷ Berlin's state government identified AM as a key growth technology and introduced two main policy actions: the opening of a 360,000m² industrial AM hub in the Marienpark in October 2020 to support the growth of the local AM ecosystem,²⁷⁸ and a decision to host the Additive Manufacturing Forum in 2021 to build the city's image as a global AM hub.²⁷⁹

²⁷⁰ Nina Paulsen, “Mehr als jedes vierte Industrieunternehmen setzt auf 3D-Druck,” bitkom, 2018.

<https://www.bitkom.org/Presse/Presseinformation/Mehr-als-jedes-vierte-Industrieunternehmen-setzt-auf-3D-Druck.html>

²⁷¹ Katharina Juschkat, “Über 40% wollen wegen Corona in 3D-Druck investieren,” Konstruktions Praxis, 2020.

<https://www.konstruktionspraxis.vogel.de/ueber-40-wollen-wegen-corona-in-3d-druck-investieren-a-947230/>

²⁷² Henning Kagermann, Wolf-Dieter Lukas, and Wolfgang Wahlster, “Industrie 4.0: Mit dem Internet der Dinge auf dem Weg zur 4. Industriellen Revolution,” VDI Nachrichten, 2011. <https://web.archive.org/web/20130304101009/http://www.vdi-nachrichten.com/artikel/Industrie-4-0-Mit-dem-Internet-der-Dinge-auf-dem-Weg-zur-4-industriellen-Revolution/52570/1>

²⁷³ “Investments in Industry 4.0 in Germany from 2013 to 2020 (in billion euros),” Statista, 2020.

<https://www.statista.com/statistics/668780/industry-40-investments-in-germany/>

²⁷⁴ “Digital Jetzt Förderung,” Digital Jetzt, 2020. <https://www.digitaljetzt-portal.de/>

²⁷⁵ “Wichtige Fragen und Antworten rund um die Förderung mit ‘Digital Jetzt,’” Bundesministerium für Wirtschaft und Energie, 2020. <https://www.bmwi.de/Redaktion/DE/FAQ/Digital-Jetzt/faq-digital-jetzt.html>

²⁷⁶ “Industry 4.0 in Saxony-Anhalt,” Invest in Saxony Anhalt, 2020.

<https://www.invest-in-saxony-anhalt.com/industry-4-0>

²⁷⁷ “Digitalisierungsprämie Plus,” Ministerium für Wirtschaft, Arbeit, und Wohnungsbau Baden-Württemberg, 2020.

<https://wm.baden-wuerttemberg.de/de/service/foerderprogramme-und-aufrufe/liste-foerderprogramme/digitalisierungspraemie/>

²⁷⁸ “Projekt im Masterplan Industriestadt Berlin 2018-2021,” Industriestadt Berlin, 2020.

<https://www.berlin.de/industriestadt/masterplan-industriestadt-berlin-2018-2021/projekte/index.php/detail/139>

²⁷⁹ “Projekt im Masterplan Industriestadt Berlin 2018-2021,” Industriestadt Berlin, 2020.

<https://www.berlin.de/industriestadt/masterplan-industriestadt-berlin-2018-2021/projekte/index.php/detail/268>



Industry Acceptance

Major industry leaders have also driven the acceptance and adoption of AM in Germany. In 2018, Siemens invested EUR 30 million in a new 3D printing facility in the UK.²⁸⁰ In 2018, BASF's Venture Capital's made its first investment in a Chinese company (Prismalab, a leading supplier of 3D printing services and machines in China).²⁸¹ In 2020, BMW opened an AM campus to consolidate its AM expertise in one location.²⁸²

Vibrant Research and Education

Research institutes in Germany have contributed to innovation in AM while providing education. In 2018, an estimated 148 research institutions were involved in German AM.²⁸³

Germany's research ecosystem is diverse and includes the Fraunhofer institute, the Helmholtz Association, the Leibniz Association, the Max-Planck-Gesellschaft, the Academies of Sciences, federal research institutions, state-owned research institutions (Germany's federal states are analogous to Canadian provinces), privately-owned industrial research institutions, industrial research associations, networks, and clusters. While federal institutions, academies, and the Max-Planck-Gesellschaft tend to focus on basic research and are mostly publicly funded, industry research associations, networks, and clusters are more concentrated on private funding and do more applied research.²⁸⁴

Given the multidisciplinary nature of AM, a likely factor in Germany's AM ecosystem is the German government's generally high commitment to R&D across all industries. In 2018, Germany's gross domestic spending on R&D grew from 2.4% to 3.1% of total GDP. In 2018, Germany had one of the most research-intensive economies in the world and was surpassed only by Israel, the Republic of Korea, Taiwan, Sweden, and Japan. By contrast, Canada's gross domestic spending on R&D dropped from 1.9% to 1.6% of total GDP from 2000 to 2018.²⁸⁵ Canada has been below the OECD average in this metric every year for last 19 years. In 2014, per capita R&D spending in Canada was ranked 22nd in the world, while Germany's was ranked sixth.²⁸⁶ This commitment to research is shared by both government and the private sector; industry-based investment in R&D accounts for more than two-thirds of all R&D funding in Germany.²⁸⁷

²⁸⁰ Kai Tubbesing, "Siemens in building a new 3D printing factory in Worcester," Hannover Messe, 2018. <https://www.hannovermesse.de/en/news/news-articles/siemens-is-building-a-new-3d-printing-factory-in-worcester>

²⁸¹ Christian Müller, "BASF invests in 3D printing specialist Prismalab," BASF, 2018. https://www.basf.com/global/de/who-we-are/organization/group-companies/BASF_New-Business-GmbH/news/press-releases/2018/p-18-367.html

²⁸² "New technology campus for 3D printing goes on stream: BMW Group builds on additive manufacturing, with skills consolidated at single site," BMW Group, 2020. <https://www.press.bmwgroup.com/global/article/detail/T0309872EN/new-technology-campus-for-3d-printing-goes-on-stream:-bmw-group-builds-on-additive-manufacturing-with-skills-consolidated-at-single-site?language=en>

²⁸³ "Research performing organizations," Research in Germany, 2020. <https://www.photonikforschung.de/service/nachrichten/detailansicht/neue-studie-lehrangebot-zur-additiven-fertigung-in-deutschland.html>

²⁸⁴ "Neue Studie: Lehrangebot zur Additiven Fertigung in Deutschland," Bundesministerium fuer Bildung und Forschung, 2018. <https://www.photonikforschung.de/service/nachrichten/detailansicht/neue-studie-lehrangebot-zur-additiven-fertigung-in-deutschland.html>

²⁸⁵ "Research performing organizations," Research in Germany, 2020. [Research performing organisations - Research in Germany \(research-in-germany.org\)](https://www.research-in-germany.org)

²⁸⁶ "Gross domestic spending on R&D," OECD, 2020. <https://data.oecd.org/rd/gross-domestic-spending-on-r-d.htm>
"Research and development expenditure (% of GDP)," World Bank, 2020. <https://data.worldbank.org/indicator/GB.XPD.RSDV.GD.ZS>

²⁸⁷ "Companies & industrial research," Research in Germany, 2020. <https://www.research-in-germany.org/en/research-landscape/research-organisations/companies-industrial-research.html>



Collaboration

Another asset in Germany's AM ecosystem is not only the individual strengths of business and research, but the highly goal-oriented collaboration between them. For example, Siemens began working with Germany's Federal Ministry of Education and Research on a grant project called IDEA in 2019. The three-year venture aims to reduce development and production times in powder-based AM by approximately 50% and to enable AM for series production. Grants involved in the venture total 14 million euros. The partners in the project include software suppliers, industrial printer manufacturers, and other firms. It is supported by two Fraunhofer institutes and the RWTH Aachen University.²⁸⁸

Prudent yet Progressive Business Culture

The success of Germany's economy in AM is supported by a business culture that balances caution and bureaucracy with liberal economic consensus, progressivism, and a wide acceptance of international trade.

A key concept in German business culture is the idea of *Mittelstand*, which doesn't translate perfectly to English. Essentially, it refers to SMEs in Germany and the characteristics that differentiate them from SMEs in other countries; these include intergenerational management structures and an emphasis of craftsmanship, specialization, and exporting.²⁸⁹ *Mittelstand* firms are widely concentrated in machinery, auto parts, chemicals, and electrical equipment. They wield substantial political clout and are seen integral to the German economic engine.²⁹⁰ A culture of shared values among German businesses may contribute to a sense of trust and industry coordination that enables more effective adoption of new technologies.

Another asset in growing AM is the attitude of German businesses toward technological change. Germany's adoption of AM is driven by a generally positive attitude toward digitalization and Industry 4.0. For example, Germany has over 220,000 industrial robots compared to just 28,600 in Canada.²⁹¹

Germany is rated as one of the top countries in the world for entrepreneurship²⁹² and innovation,²⁹³ and ranks similarly to Canada on the ease of doing business.²⁹⁴

²⁸⁸ "Siemens to lead Germany's Industrial Additive Manufacturing Plan," 3D Printing Industry, 2019. <https://3dprintingindustry.com/news/siemens-to-lead-germanys-industrial-additive-manufacturing-plan-159051/>

²⁸⁹ Karan Girotra, Serguei Netessine, "Extreme Focus and the Success of Germany's Mittelstand," Harvard Business Review, 2020. <https://hbr.org/2013/02/good-old-focused-strategy>

²⁹⁰ Jana Randow, Aaron Kirchfeld, "Germany's Mittelstand Still Thrives," Bloomberg Businessweek, 2010. https://web.archive.org/web/20101009040157/http://www.businessweek.com/globalbiz/content/sep2010/gb20100929_905740_page_2.htm

²⁹¹ "Deutschland ist am stärksten automatisierte Volkswirtschaft der EU," Industrie.die, 2020. <https://industrie.de/arbeitswelt/deutschland-ist-am-staerksten-automatisierte-volkswirtschaft-der-eu/>

²⁹² "Best Countries from Entrepreneurs," US News, 2020. <https://www.usnews.com/news/best-countries/entrepreneurship-rankings>

²⁹³ Michelle Jamrisko, Wei Lu, "Germany Breaks Korea's Six-Year Streak as Most Innovative Nation," Bloomberg, 2020. <https://www.strategyand.pwc.com/de/de/presse/2018/unternehmenskultur.html>

²⁹⁴ "Ease of Doing Business rankings," Doing Business, World Bank, 2020. <https://www.doingbusiness.org/en/rankings>



Lessons for Canada

Germany's example shows that smaller R&D-focused economies can develop diverse AM ecosystems and compete effectively with larger countries.

The following key actions, based on the German example, can serve as a model for Canada to build a strong AM ecosystem. Most of these actions could also benefit Canada's economy across all sectors due to the disruptive impact of AM and, more generally, Industry 4.0.

Action Ideas for Government

- Invest more in Industry 4.0 across applications and more generally in industrial innovation.
- Increase incentives to adopt disruptive technologies (including AM specifically) by firms of all sizes, particularly to SMEs. Germany's *Digital Jetzt* program may serve as a model for funding.²⁹⁵
- Increase Canada's R&D expenditure as a percentage of GDP. At present, Canada is not just behind its top competitors in AM but also the EU and the OECD average. This can be done directly by the government and educational institutions and indirectly by giving incentives to industry to invest in R&D.
- Invest in building greater awareness of AM technology and its applications among businesses and educational institutions.
- Fund the creation of specialized scientific research institutes across Canada to accelerate industrial AM applications development and to introduce industry and education to cutting edge AM applications.
- Continue promoting free trade agreements (such as the Comprehensive Economic and Trade Agreement [CETA]) and the specific expertise of the Canadian AM industry in niche applications, with the goal of building partnerships with German AM-focused businesses that will allow for transfers of knowledge and expertise.
- Encourage and incentivise large domestic firms to think "big" and adopt AM and Industry 4.0 as a means of remaining competitive internationally in the long term.

Actions for Educational Institutions and Research Institutes

- Push for partnerships with the US and Germany in AM research.
- Increase investments in AM research and, more generally, in Industry 4.0.

Actions for Educational Institutions and Research Institutes

- Mobilize and build stronger relationships.
- Take on more ambitious projects that increase the profile of AM in Canada.

²⁹⁵ More about the *Digital Jetzt* program can be found at:
<https://www.bmwi.de/Redaktion/DE/FAQ/Digital-Jetzt/faq-digital-jetzt.html>



The Demand for AM Talent

Highly skilled talent is the key to the successful growth of AM as well as the continuing competitiveness of the entire manufacturing sector.²⁹⁶ Similarly, the relatively small supply of capable and skilled AM professionals has long been identified as a key challenge impacting the ability of AM to scale, even among “AM leaders” such as the US.²⁹⁷ With the growth and advancements of AM technologies and the development of new materials, there has been a growing demand for AM professionals.

Existing literature on AM talent notes that instruction in AM is poorly integrated into existing design and engineering curricula and that this problem is global in scope. Furthermore, falling costs of printers and rising exposure to the technology will not, on its own, solve the talent gap because effective AM professionals require a mix of technical knowledge, industry experience, and soft skills. For example, a study of AM talent demand by Deloitte in 2019 found that five key attributes were desired by employers, and that each of these attributes included various specialized qualities:²⁹⁸

- ▶ Multidisciplinary knowledge (including physics, software, materials science, and a specialized knowledge of AM technologies)
- ▶ Design knowledge, particularly Design for Additive Manufacturing (DfAM)
- ▶ High creativity and open-mindedness about design (to the extent that a high level of experience in traditional manufacturing may be undesirable)
- ▶ Knowledge of traditional manufacturing and an understanding of AM's comparative strengths and weaknesses in the competitive landscape of manufacturing technologies
- ▶ A commercial mindset (including a knowledge of economics, business skills, industry experience, and soft skills) that allows workers to identify potential use cases for AM, evaluate their feasibility, and “sell” the proposition to their organizations

Limited working experience with a 3D printer is no sufficient for industry employability, so a coordinated effort between academia and industry is essential in ensuring that the demand for AM talent is satisfied.

ICTC's primary research finds that Canadian AM-focused organizations represent a diverse group, ranging in size from single-person startups to corporations of several thousand individuals. Organizations vary in the number of AM specialists they employ. The larger organizations tend to have a smaller portion of their total workforce in AM-related roles, as they are usually adopting AM technologies to augment existing manufacturing processes, rather than developing a novel, AM-based business. Smaller companies (with fewer than 100 employees), which are more likely to focus on AM as a product in itself or as the basis of their business, employ a higher proportion of AM specialists. Many study participants at organizations using AM technologies, regardless of size and proportion of AM specialists, experienced an increase in demand for AM talent.

²⁹⁶ “Experts In Demand: Growth in Metal AM Creates Need for Professionals,” *SME*, 2018. <https://www.sme.org/am3dmetalsjob/>

²⁹⁷ “3D opportunity for the talent gap,” *Deloitte Insights*, 2016. <https://www2.deloitte.com/us/en/insights/focus/3d-opportunity/3d-printing-talent-gap-workforce-development.html>

²⁹⁸ “3D opportunity for higher education,” *Deloitte Insights*, 2019. <https://www2.deloitte.com/us/en/insights/focus/3d-opportunity/additive-manufacturing-higher-education-degree.html>



Five to six years ago, there was almost no mention of AM jobs, now AM is practically a buzzword.

– AM Specialist, Automation, Quebec

Figure 4: : AM and 3D Printing Job Postings Trend, November 2017 - December 2020

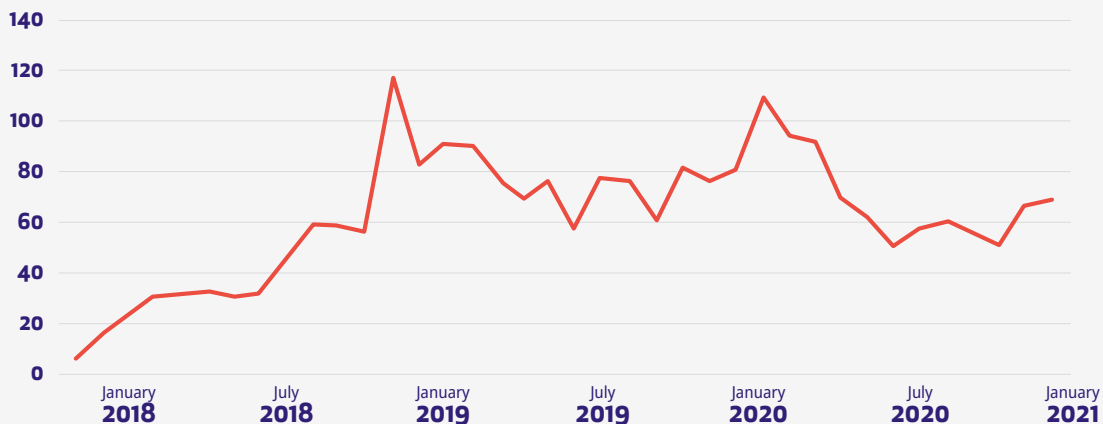

Source: Emsi Data, accessed in January 2021

The figure above shows the job posting trend in occupations that list 3D Printing or AM as one of the required skills. The job postings data was collected across all industries in Canada. The job posting data covers November 2017 to December 2020 (July to December 2020 is a forecast). In general, job posting data is a common and relevant metric for assessing the demand for certain roles. Although, many interviewees reported growth in AM demand for talent over the last couple of years, job posting data shows fluctuation in demand during 2019 and a drop in demand during 2020. It is worth noting, however, that the manufacturing sector overall, and specifically the companies working with AM technologies, rely heavily on informal or internal recruitment methods and practices (as opposed to posting jobs on a job search platforms). Because of this, the data in the figure above only partially captures the demand for AM talent.

Anticipated Hiring

When asked about their hiring plans over the next one to two years, industry participants in this study asserted that hiring would remain modest for the foreseeable future. Overall, the demand for talent is not expected to see a sharp increase over the next one to two years. Most study participants said their organizations were either planning to remain at their current size or grow slightly, while several expected delayed hiring due to volatility resulting from the COVID-19 pandemic. Expansive hiring plans were most common in large organizations (while the overall hiring numbers are larger at these companies, AM-specific talent makes up a smaller portion of the work force).

Talent Availability

On the topic of talent availability in Canada, study participants relayed that overall, the challenge was not one of quantity but quality. That is, while the total volume of talent needed is modest in the near-term, employers faced challenges finding the skilled talent to fill open roles. Most of the time those roles are highly technical or DfAM-focused. Some participants mentioned that general interest in AM has grown over the years, and as a result amateur AM users frequently apply for AM roles believing that they meet educational or work experience requirements.



We were recently just looking for a 3D printer technician and we just put it out on the local channel. Within a few days, we had several dozen applicants that range from hobbyists to PhDs, drafts-people and everything in between. So there's a lot of people out there that I think could easily be trained for these roles.

- Manager, Education, Alberta

However, when it came to sourcing AM talent in Canada, there was little consensus among participants about the best way to source it. For junior positions many organizations often engage directly with university or college programs. For mid and senior roles, organizations reported using largely informal recruitment methods, including engagement with potential talent at trade shows and a reliance on their own personal networks. As a result, job posting data only reflects a portion of all hiring in this sector.

In-Demand Roles

With the proliferation and evolution of AM processes and materials, labour requirements for the AM ecosystem are also changing. According to study participants, there is limited consensus on what an “AM specialist” should be able to do; rather, the specific job titles posted vary widely and reflect the unique needs of an organization. For example, a company exploring metal AM research might prefer a Mechanical and Materials Engineer with a PhD and extensive background in a specific metal AM processes, while a AM service bureau might prefer a design engineer with extensive CAD experience for AM.

Table 4: Top 15 Technical AM Roles

AM Engineers	Process Engineers	Product Design Engineers
Manufacturing Engineers	Project Engineers	Designers
Mechanical Engineers	Software Engineers	3D Printing / AM Technicians
Materials Engineers/Scientists	Software Developer	Engineering Technicians
Application Engineers	Design Engineers	Machinists

Source: ICTC, 2020

Leveraging input gathered from key informant interviews and the industry advisory committee members in this study, nearly 50 roles are common to AM. While numerous jobs are relevant to AM technologies, certain jobs are more in demand and harder to fill than others. According to study participants, the most in-demand technical roles in AM were various types of traditional engineering roles, including Materials Engineers/Scientists, Manufacturing Engineers, Mechanical Engineers, Application Engineers, Process Engineers, and Project Engineers. These are followed by various types of Designers or Design Engineers as well as various roles found on the shop floor, including 3D Printing/AM Technicians, Engineering Technicians, and Machinists. Software Engineers and Developers were frequently mentioned as a role with connections to AM, given their connection to the development of hardware and software for 3D printers. AM-related roles mentioned less frequently included digital artist, hardware manager, applications specialist, robotics engineer, mechatronics engineer, and computational geometry specialist.



I think it's actually people working on the floor [that we need]. As much as PhDs and Master's students are going to be very important to our strategy on the long run, they are not the most in-demand talent today. I have some friends in Toronto working in additive manufacturing of metals, and they mention having a hard time finding talent that has ever used a 3D printer before to run their six DMLS [Direct Metal Laser Sintering] machines. We need more people who have at least some sort of basic knowledge.

– Executive, AM Consultancy, Ontario

Key Skills for In-Demand Roles

Generally, AM talent requires a variety of competencies and skills. These include a unique blend of multidisciplinary skills: engineering skills, digital skills, manufacturing process, material science, product design, robotics, computational data analytics²⁹⁹ and soft skills, such as creativity and teamwork. Some of those skills are acquired at school but most are gained through work experience. Based on study participant feedback, most AM professionals in the sector with more than five years of experience started their careers in traditional manufacturing and slowly transitioned to AM.

However, the specific competencies and skills needed for each role varies and is often related to the AM technologies available and the materials being used. For example, AM talent working with plastics does not necessarily have the skills needed for roles in metal AM.

The following figure is a representation of top skills and competencies required for in-demand AM roles. Due to the limited supply of Canadian data (as can be seen in Figure 4, which showed approximately 50 job postings per month in 2020), the data represented below comes from US postings in this space, representing a larger sample size needed to extract insights on skills and a national industry further along the AM maturity curve than Canada.

²⁹⁹ "Training the manufacturing workforce for tomorrow," Waterloo Stories, 2020. <https://uwaterloo.ca/stories/global-impact/training-manufacturing-workforce>

Figure 5: Top technical skills for in-demand AM roles

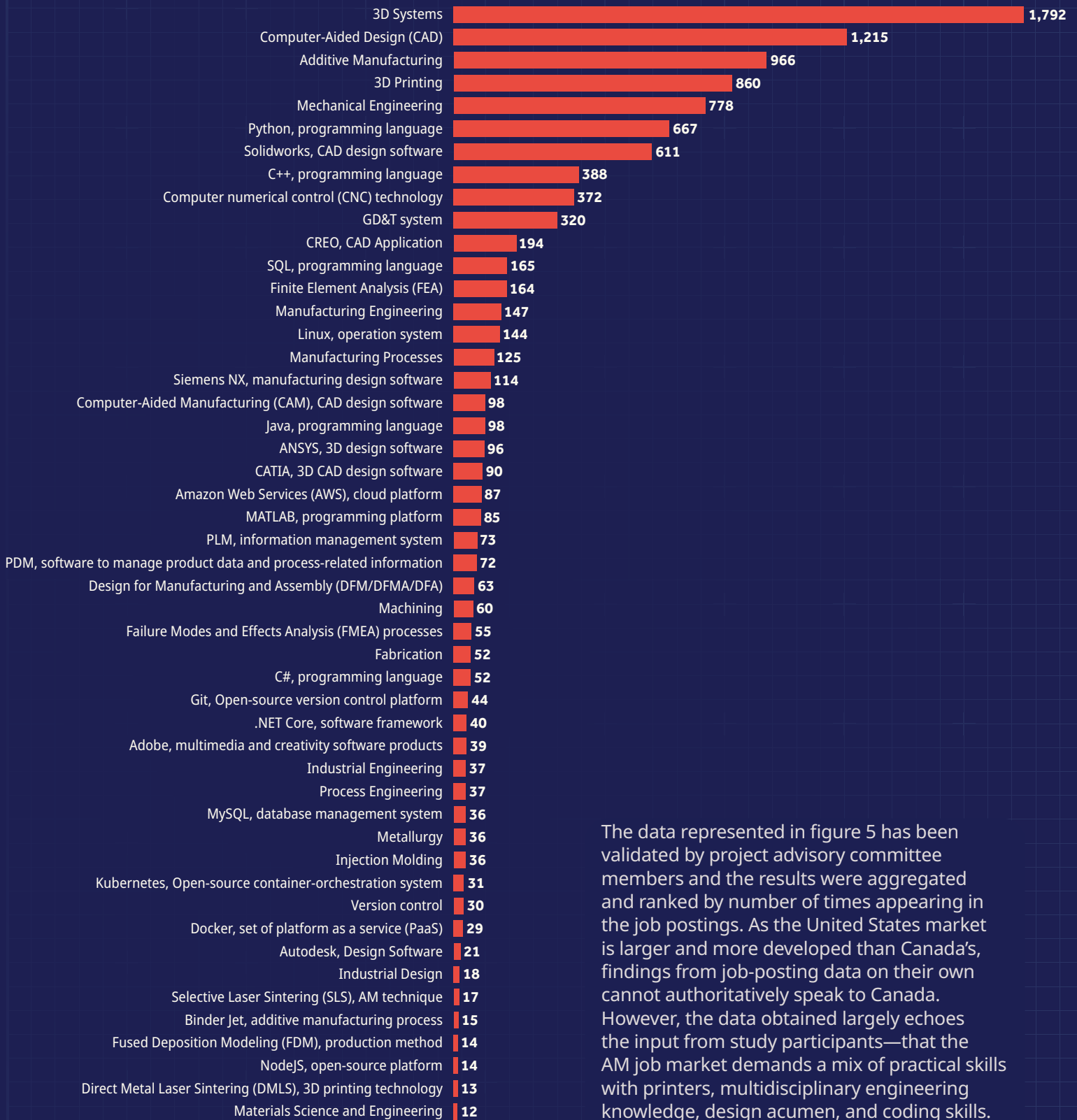

The data represented in figure 5 has been validated by project advisory committee members and the results were aggregated and ranked by number of times appearing in the job postings. As the United States market is larger and more developed than Canada's, findings from job-posting data on their own cannot authoritatively speak to Canada. However, the data obtained largely echoes the input from study participants—that the AM job market demands a mix of practical skills with printers, multidisciplinary engineering knowledge, design acumen, and coding skills.

Source: ICTC, 2020

Interviewees went further to suggest that two of the most in-demand hard skills for AM talent (overall) were Design for Additive Manufacturing (DfAM), and experience with CAD. Also, in high demand was “general mechanical or technical skills” , “comfort working with machines,” metallurgy, programming, general computer science skills, as well as 3D modelling.

As much technical or “hard skills” are required, soft skills were regarded as equally important by industry participants. In addition to experience working in sales, study participants underlined that AM specialists must be creative with an innovative mindset, resourceful, possess the ability to “think outside of the box,” be customer oriented, and have a commercial mindset to understand the AM business case in various situations.³⁰⁰

Education Requirements

Among study participants, there were many competing “schools of thought” on what the appropriate educational background should be for an AM professional. Although many participants could not specify a formal minimum educational requirement, all participants felt that academia does not equip students with all the necessary skills, and that there will always be a large degree of on-the-job learning needed to get junior talent up to speed. Almost all participants agreed that AM is a very idiosyncratic field and that there is no “perfect” educational background for an AM professional. However, as stated previously, participants mentioned that while AM roles require some type of a post-secondary education, a PhD was “overkill” for many roles.

Figure 6: Requested Level of Education for 815 AM-related Job Postings, November 2017 - June 2020

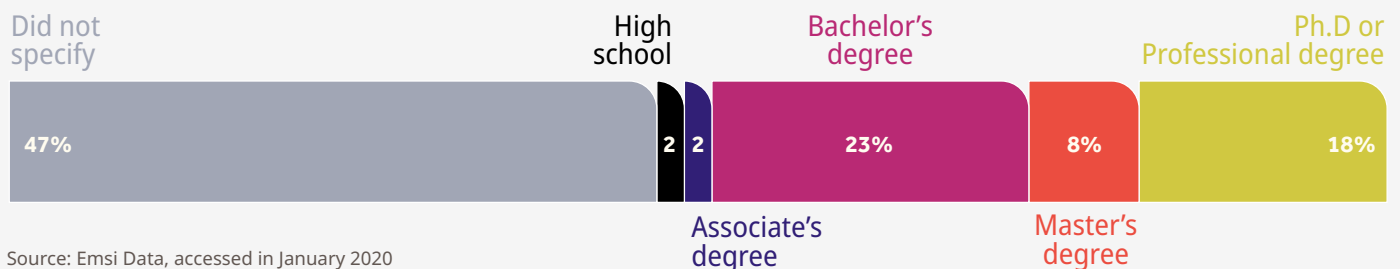

Source: Emsi Data, accessed in January 2020

³⁰⁰ “3D opportunity for the Talent Gap,” Deloitte Insights, 2016. <https://www2.deloitte.com/us/en/insights/focus/3d-opportunity/3d-printing-talent-gap-workforce-development.html>

Likewise, an analysis of 815 unique job postings for roles related to AM (see results above) revealed that employers are primarily looking for specific skills and experience and are less concerned with specific educational credentials. Almost half (47%) of roles advertised from November 2017 to June 2020 did not specify a preferred level of education, 2% asked for an Associate's degree, 23% asked for a Bachelor's degree, 8% preferred a Master's degree, and another 18% requested a PhD. AM professionals with a PhD were primarily sought after by universities and colleges to teach various AM-related courses.



The minimum I would settle for is a degree in mechanical or electrical engineering. I might let that slide, but only if they have proven experience working in what I need. At least the degree gives me an indication of their level of confidence. If they have exact experience I need, the degree wouldn't be required.

– Production Lead, Consumer Retail, Atlantic Canada

Work Experience Requirements

There was general agreement among participants that AM personnel should, ideally, be familiar with both AM and traditional manufacturing techniques (whether through work or education). However, it was also generally acknowledged that the number of truly proficient AM professionals is very small, and that it would not be practical, from a business perspective, for companies to restrict themselves to hiring only them. Talent from outside of the field could, with sufficient interest and commitment, become proficient in the field. There was general agreement on the importance of practical experience in working with machines. Several interviewees believed that it takes around a year to a year and a half of working with a specific set of hardware and processes to become a truly proficient operator of AM technology. The ideal AM employee is someone with the ability to adapt rapidly and possessing a mix of experience in both AM and traditional manufacturing to “bridge the gap” between the two technologies.



It's almost as bad to be a total specialist in AM as it is to know nothing about it. We need programs that teach people both AM and subtractive manufacturing, not a subtracting manufacturing program with a course in additive. We need to bridge the gap.

– Postdoctoral Fellow, Education, Ontario

It would not be practical to only hire people with previous AM experience. People with broad experience in AM are not really there. And if they exist, they will probably cost more than what we're willing to spend, frankly. You don't need that kind of experience for what we're doing. As AM grows and matures as a technology, we'll see more people with more industry experience. For those we hire, they need to have a curious mind and ask the necessary questions around design and the process, be able to push boundaries of the technology.

– AM Lead, Aerospace, Atlantic Canada

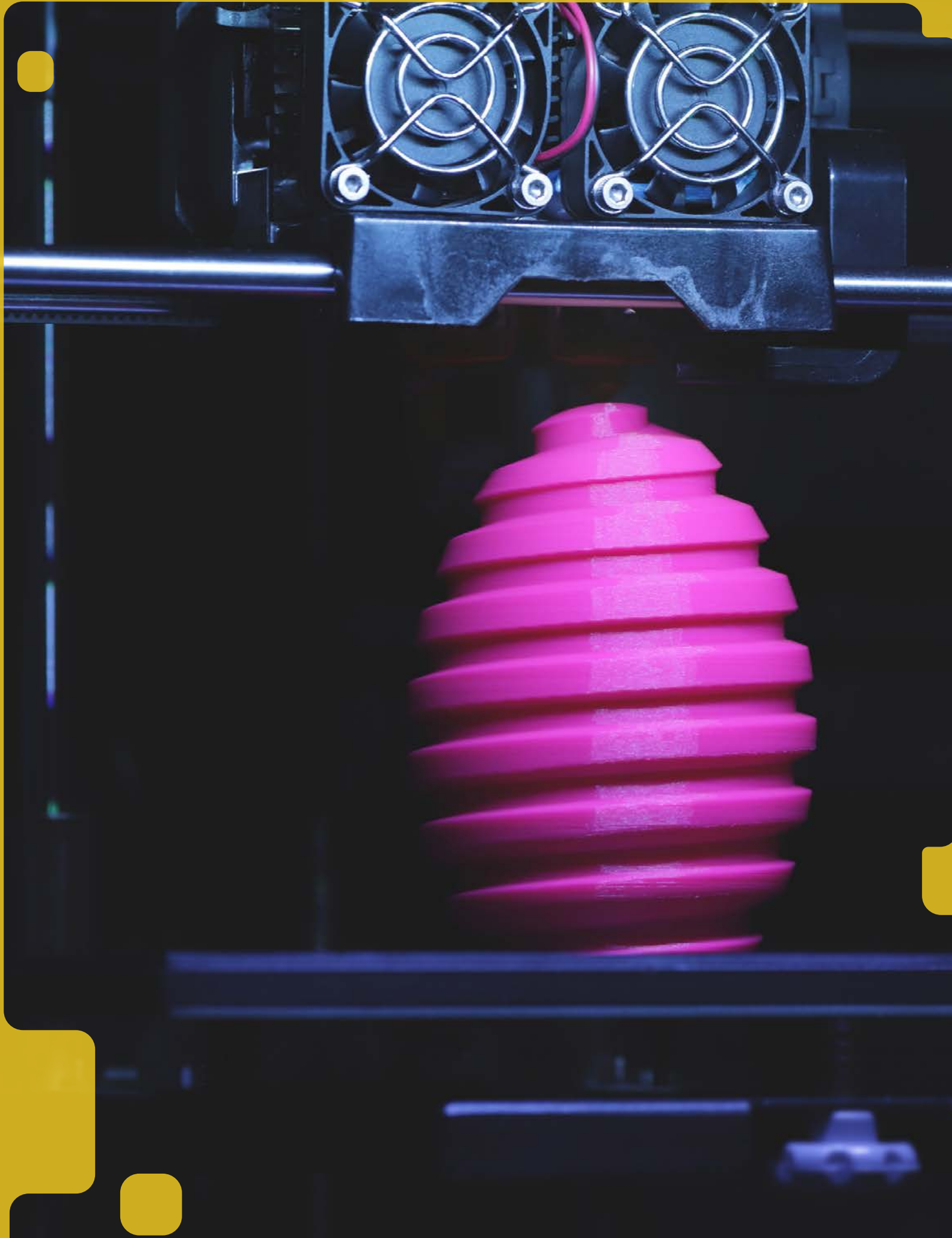



The Impact of COVID-19 on Additive Manufacturing

The COVID-19 outbreak, first identified in December 2019 and formally declared a pandemic in March 2020,³⁰¹ has exerted a strong influence on the AM industry across the world. Overall, it is difficult to characterize the pandemic as being “good” or “bad” for the sector, as experiences and challenges resulting from the pandemic vary widely from organization to organization. In addition, many effects (such as increased awareness) are impossible to quantify or are not necessarily long term in nature.

Initially, the COVID-19 pandemic posed a major challenge to existing manufacturing paradigms. Firstly, meeting the demand for medical devices parts required a sizeable realignment of specialized production capabilities. In addition, there was a considerable spike in demand for less complex manufactured goods (such as masks, mask straps, face shields, and nasal swabs). Finally, the COVID-19 pandemic demanded rapid production of essential goods while creating a disruption of existing supply chains. There were many reasons to be optimistic about AM’s capabilities to assist in the fight against the virus. Firstly, AM is well suited to the production of complex or unique parts with limited cost, which made it ideal for producing complex objects like ventilator parts on short notice. While AM was not suited in the long term to produce mass quantities of simple manufactured goods (such as masks and swabs), it had an advantage in speed over traditional manufacturing. It could, then, be mobilized quickly to “stem” the demand for certain goods before the existing mass-production infrastructure could be shifted. As an example, in October of 2020 Precision ADM announced an investment in the production of 8 million nasopharyngeal swabs per month for Canada.³⁰² Finally, AM represented a way to circumvent reliance on disrupted supply chains; simply having access to plastic and printers could enable rapid production to many essential goods that would have otherwise required shipping.

AM-produced medical products were used in a wide range of countries, including France,³⁰³ Germany,³⁰⁴ Ireland,³⁰⁵ the US³⁰⁶ and the UK.³⁰⁷ Several international AM initiatives were formed, including the World Economic Forum’s 3D Printing Rapid Response Initiative, which was supported by global leaders including GE, EOS, and HP.³⁰⁸ On March 11 of 2020, Canada’s federal government issued an appeal across the country to produce a wide range of goods including disposable N95 masks, surgical masks, nitrile gloves, and hospital gowns.

301 Jamie Ducharme, “World Health Organization Declares COVID-19 a ‘Pandemic.’ Here’s What That Means,” *Time*, 2020. <https://time.com/5791661/who-coronavirus-pandemic-declaration/>

302 “Gatineau plant aiming to produce up to eight million COVID-19 test swabs a month,” *Ottawa Business Journal*, 2020. <https://obj.ca/article/techopia/gatineau-plant-aiming-produce-eight-million-covid-19-test-swabs-month>

303 “Covid-initiatives,” *Gouvernement de France*, 2020. <https://www.data.gouv.fr/fr/reuses/covid-initiatives-org/>

304 “Schnelle Hilfe für Kliniken in der Corona-Krise,” *Industrie.de*, 2020. <https://additive.industrie.de/news/schnelle-hilfe-fuer-kliniken-in-der-corona-krise/>

305 Chris Mills Rodrigo, “Irish health officials to review 3D-printed ventilator,” *The Hill*, 2020. <https://thehill.com/policy/technology/488637-irish-health-officials-to-review-3d-printed-ventilator>

306 “3D Printing in FDA’s Rapid Response to COVID-19,” *US Food and Drug Administration*, 2020. <https://www.fda.gov/emergency-preparedness-and-response/coronavirus-disease-2019-covid-19/3d-printing-fdas-rapid-response-covid-19>

307 “3D Printing (additive manufacturing) of medical devices or component parts during the coronavirus (COVID-19) pandemic,” *Government of the United Kingdom*, 2020. <https://www.gov.uk/guidance/3d-printing-additive-manufacturing-of-medical-devices-or-component-parts-during-the-coronavirus-covid-19-pandemic>

308 “3D Printing COVID-19 Rapid Response Initiative,” *World Economic Forum*, 2020. <https://fr.weforum.org/platforms/covid-action-platform/projects/3d-printing-covid-19-rapid-response-initiative>



The Prime Minister of Canada Justin Trudeau specifically called out the capabilities of 3D printing to respond to the demand for medical supplies.³⁰⁹ Many of Canada's leading AM organizations (including Exergy Solutions,³¹⁰ CAD MicroSolutions, Precision ADM, and Javelin Technologies³¹¹) mobilized to support this effort, as did many small-scale producers and universities (including SFU,³¹² UBC,³¹³ and McGill³¹⁴). The worldwide mobilization of AM was noted in many publications worldwide, including the Wall Street Journal,³¹⁵ the Globe and Mail,³¹⁶ the Financial Times,³¹⁷ USA Today,³¹⁸ the BBC,³¹⁹ Deutsche Welle,³²⁰ and Le Monde.³²¹ Some publications, such as the New York Times, even used their reach to propagate instructions for how to print medical equipment.³²² Widespread media coverage of success stories led to the sentiment that AM had "come of age" during the pandemic.^{323,324,325} Even among organizations that were not focused on producing medical equipment, COVID-19 has offered an opportunity to demonstrate the agility of AM processes. For example, Relativity Space (which incorporates AM extensively into their production of rockets for space travel) has been able to continue production and even hire new personnel, and their operations having been minimally affected by lockdowns.³²⁶

Participants in this study overwhelmingly felt that COVID-19 had led to a growth in awareness of AM, as well as increased acceptance of the technology for creating finished products. Some mentioned "wins" in the Canadian AM ecosystem, such as Winnipeg-based Precision ADM becoming the single largest producer of 3D-printed medical devices in the world.³²⁷

- 309** Tess Boissonneault, "Canadian government calls for help for COVID-19 supplies," 3D Printing Media Network, 2020. <https://www.3dprintingmedia.network/canadian-government-covid-19-supplies-help/>
- 310** Emily Mertz, "Coronavirus: Local companies make ventilators, face shields and donate them to Alberta Health Services," Global News, June 2020. <https://globalnews.ca/news/7031253/alberta-health-services-face-shields-ppe-ventilators-exergy-solutions-coronavirus/>
- 311** "Canadian AM community responds to COVID-19 crisis," Design Engineering, 2020. <https://www.design-engineering.com/canadian-am-community-responds-to-covid-19-crisis-1004034630/>
- 312** "SFU Engineering students use 3D printing skills to develop COVID-19 supplies," SFU News, 2020. <https://www.sfu.ca/sfunews/stories/2020/04/sfu-engineering-students-use-3d-printing-skills-to-develop-covid.html>
- 313** Nataly El-Bittar, "UBC students 3D printing PPE to distribute to essential workers around Vancouver," The Ubyyssey, 2020. <https://www.ubyssey.ca/science/project-shield-vancouver/>
- 314** Kwabena Odura, "Coronavirus: McGill University students design 3D-printable masks for health-care workers," Global News, 2020. <https://globalnews.ca/news/6727301/coronavirus-mcgill-students-3d-face-masks/>
- 315** Daniel Michaels, Asa Fitch, "3-D Companies Tackle Coronavirus Supply Shortages," The Wall Street Journal, 2020. <https://www.wsj.com/articles/3-d-companies-tackle-coronavirus-supply-shortages-11585832400>
- 316** Tom Cardoso, "Stuck in self-isolation, these Canadians are using their skills to make medical supplies," The Globe and Mail, 2020. <https://www.theglobeandmail.com/canada/article-canadians-use-crowdsourcing-to-produce-medical-supplies-for-health/>
- 317** "3D Printing can be a real source for optimism," Financial Times, 2020. <https://www.ft.com/content/1c07fa6d-b92c-47d3-a70e-5e29d3109f0c>
- 318** Ryan Streeter, "From robots to 3D printing, how coronavirus can inspire waves of innovation," USA Today, 2020. <https://www.usatoday.com/story/opinion/2020/05/18/how-coronavirus-can-inspire-new-era-economic-innovation-column/5197093002/>
- 319** Zoe Kleinman, "Coronavirus: 3D printers save hospital with valves," BBC, 2020. <https://www.bbc.com/news/technology-51911070>
- 320** Kerstin Schweizer, "3D printers offer thrilling opportunities to tackle the coronavirus," Deutsche Welle, 2020. <https://www.dw.com/en/3d-printers-offer-thrilling-opportunities-to-tackle-the-coronavirus/av-52935297>
- 321** Pierre Bouvier, "Respirateurs, protections pour les soignants l'impression 3D mobilisée contre le coronavirus," Le Monde, 2020. https://www.lemonde.fr/planete/article/2020/03/31/respirateurs-protections-pour-les-soignants-l-impression-3d-mobilisee-contre-le-coronavirus_6035086_3244.html
- 322** Signe Brewster, "Have a 3D printer? You can use it to make Face Shields for Medical Workers," New York Times, 2020. <https://www.nytimes.com/wirecutter/blog/3d-printer-coronavirus-face-shield/>
- 323** Aaron Rabinowitz, "3D Printing Comes of Age in the COVID-19 Crisis," IP Intelligence Report, 2020. <https://www.ipintelligencereport.com/2020/04/02/3d-printing-comes-of-age-in-the-covid-19-crisis/>
- 324** Yu Ying Clarrissa Choong, Hong Wei Tan, et al., "The global rise of 3D printing during the COVID-19 pandemic," Nature Review Materials, 2020. <https://www.nature.com/articles/s41578-020-00234-3>
- 325** Brooke Sutherland, "3D Printers Recast Virus-weary Supply Chains," Bloomberg, 2020. <https://www.bloomberg.com/opinion/articles/2020-04-09/coronavirus-3d-printers-remake-broken-supply-chains>
- 326** Michael Sheetz, "Space startup Relativity verified its 3D printing process works to build a rocket," CNBC, 2020. <https://www.cnbc.com/2020/05/12/relativity-space-verifies-3d-printing-works-to-build-its-rocket.html>
- 327** "How Precision ADM became the Largest Producer of 3D Printed Medical Devices," Formlabs, 2020. <https://formlabs.com/blog/precision-adm-3d-printed-medical-devices/>



Prior to COVID-19, most of the AM printers were doing more prototyping. And COVID-19 has really launched them into full-scale 24/7 manufacturing. We've got three of our partners who have now become fully ISO certified through this. So I think the experience they're getting with this is going to make them a lot more focused on actual manufacturing options versus more heavily weighted on the prototyping side, because, frankly, they're going to make a lot more money. They're having six months, perhaps even another year of experience, to do it all – hire the right people, get the right resources, train their people properly, provide all the service capability they need.

– Executive, Manufacturing, Ontario

However, some did mention a negative side to the increased publicity surrounding AM. They felt that media coverage unrealistically portrayed AM as a “magic bullet” manufacturing solution, which led to unrealistic expectations about the capabilities of the technology. Some felt that the coverage had created a sort of “mania” around AM, where the technology was rapidly adapted without seriously considering the sustainability, suitability, or even safety of AM materials.



I hear some of this hype and feel-good news about 3D printing being used to make tools and PPE, but other kinds of manufacturing are far more suited to this work. If you want to make 100,000 things, you don't 3D-print them. You set up a production line.

– Business Owner, Engineering, British Columbia

A lot of people didn't consider things like particle porosity. For example, in FDM (fused deposition modelling), the holes that the process naturally leaves are 10 times larger than COVID-19 viruses. A lot of people in plastic just lacked the technical knowledge to make products safely for the health industry.

– Executive, AM Consultancy, Ontario

A recurring theme among participants was that the COVID-19 pandemic illustrated Canada's poor AM supply chains and the low self-sufficiency of its AM industry. Many interviewees noted significant delays in receiving parts and machines. Also frequently mentioned was that filament manufacturers had been “swamped” by demand and that the US had seized all of the filament, some of which might have otherwise gone to Canada. Others mentioned having machines sitting idle, because they had not been able to receive support from tech representatives in the US. Overall, study participants felt the pandemic highlighted the fragility of Canada's AM ecosystem, which lacks large equipment manufacturers, polymer extruders, polymer manufacturers, post-processing facilities, large-scale printer farms, and is heavily dependent on the US for filament.



Although not an opinion that was shared by all participants, one interviewee succinctly summed up the COVID-19 pandemic as a “baptism of blood.” He noted that while it had exposed Canada’s weaknesses in AM and may have even damaged the reputation of the sector in the short term, it also offered opportunities for learning and growth and refocusing the sector. The most common viewpoint was that the pandemic, in the long run, provided an opportunity for the sector because it would disrupt existing paradigms, increase awareness, educate, and give the technology a chance to demonstrate its advantages and capabilities.



The only risk is if we fail to deliver the promises we have made to the market. The technology holds great promise, but how fast we reach it will determine if we rise or stagnate. It is possible that we could fail to make the most out of the technology. But right now, investments are there, and people are pushing. Everything is aligned for continued growth.

– AM Specialist, Automation, Quebec

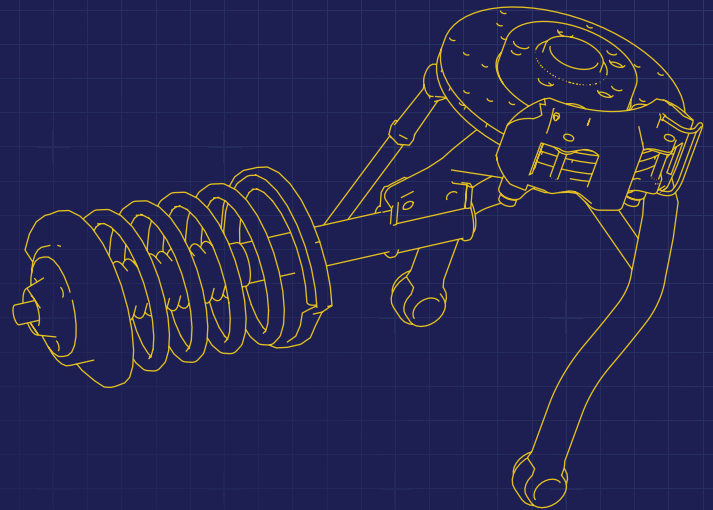

Conclusion

AM technologies represent a small, rapidly growing share of the global manufacturing landscape. While AM has existed since the 1980s, several factors have appeared in the last decade that align the AM industry for rapid, sustained growth in the future. Lower costs of printers and feedstock have enabled wider adoption across organizations, particularly SMEs. Growing diversity in materials and process variants has expanded the number of potential use cases. Finally, technological improvements have enabled AM to mitigate some of its weaknesses while maintaining its advantages over traditional manufacturing processes. With hundreds of possible use cases existing for AM, it has the potential to rapidly impact sectors such as automotive, aerospace, industrial manufacturing, cleantech, construction, consumer retail, and health/biotech.

Canada represents around 2% of the global AM market. When compared to the leading international players (such as the US, China, and Germany), Canada's AM ecosystem has numerous weaknesses besides its small size. While Canadian organizations often use AM to prototype, a lack of awareness, coupled with unclear business cases can cause risk aversion in investment, delaying the adoption of AM for other uses. Canada's AM ecosystem is relatively "siloe" between industries and regions, resulting in an inefficient use of resources and limited collaboration. With the notable exception of metal powder, where it has developed considerable expertise, Canada has few OEMs or materials producers, making it dependent on international supply chains and contributing to higher costs for Canadian-produced products. In several sectors, including aerospace and construction, organizations seeking to produce end-use parts via AM have been delayed by unfinished certifications and standards. Also, existing AM education, apart from PhD programs, is superficial, even at leading institutions; as a result, the labour market has become saturated with PhDs, even though the most in-demand AM jobs are technician roles that could be filled by college graduates.

However, there are several niches of AM in which Canada is highly competitive. Centred in Quebec, a vibrant, diverse metal AM ecosystem exists, which has drawn leading multinational organizations such as GE, Siemens, and Pratt & Whitney. It includes raw materials producers, industrial adopters, research councils, and educational institutions. Biomedical applications of AM have also received substantial attention from government and domestic industry. Canadian laboratories, and companies such as Manitoba-based Precision ADM are at the forefront of research and development in biomedical AM.

Germany's example proves that smaller economies can develop diverse AM ecosystems and compete effectively against far larger economies such as the US and China. Making similar, bold policy choices can help increase the competitiveness of Canada's AM ecosystem. These include increasing investment in industrial innovation and in campaigns to spread awareness of AM and its applications, incentivising the adoption of AM technologies, especially among SMEs, and boosting Canada's R&D investment in AM, whether directly through additional funding to universities or industry, or indirectly through tax credits. Both the private sector and government can be active in promoting Canadian expertise in AM within Canada and abroad, developing partnerships with leading countries in AM research (such as Germany, the US, and China), and fostering stronger relationships between key players in Canadian AM to encourage more ambitious projects. Hosting more global AM-related conferences in Canada would be a particularly effective way to showcase Canadian expertise in AM to both Canadian businesses and global AM leaders.

The COVID-19 pandemic is an unprecedented disruption to existing economic paradigms, as well as an opportunity to reorient Canada's economy toward high-growth industries. AM has, to some degree, emerged from the pandemic as an area of opportunity, with numerous applications and a promising growth trajectory. While the size of the Canadian AM ecosystem is unlikely to reach that of the US or Germany, investing in Canada's strengths in AM is an opportunity to enhance Canada's economic competitiveness.

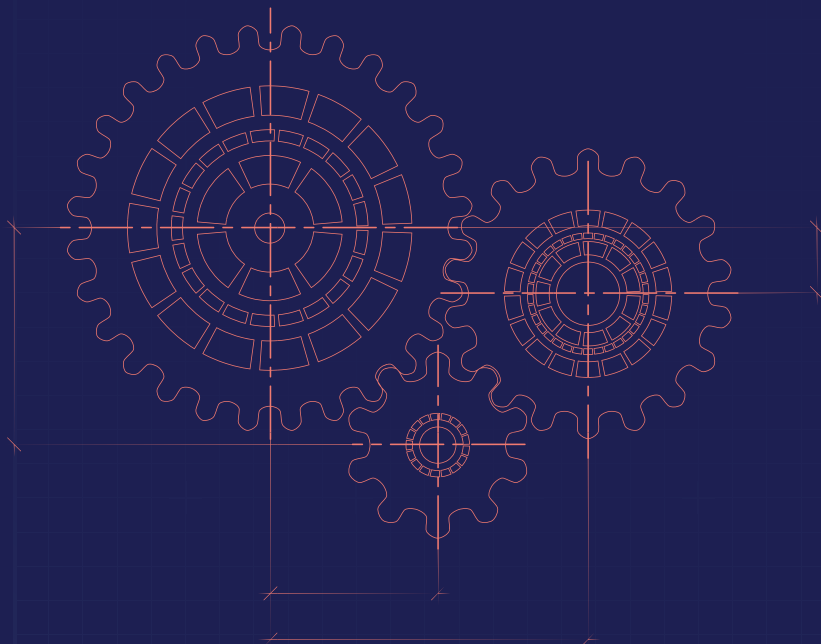

Appendix

Research Methodology

This study comprises both secondary and primary research.

Secondary Research

Secondary research was informed by a comprehensive and robust existing AM literature review, offering a detailed understanding of AM technology that is shaping the industry. Publications were sourced from industry and academia, and some of those were provided to ICTC by KII participants and advisory committee members.

In addition to the literature review, secondary data sources were assessed, including Emsi labour analytics data, job posting data from the leading websites, and other publicly available sources. Secondary data sources were analyzed to understand market trends pertaining to economic impacts, job growth, and demand for skilled AM talent.

Primary Research

Key Informant Interviews

Between June and September 2020, ICTC completed 26 semi-structured key informant interviews with subject-matter experts from industry, industry associations, government, and academia. Organizations interviewed ranged in size (from a single-person startups to companies with several thousand employees), location, maturity levels, revenue, employment needs, and the number of AM specialists they employed.

Interview participants held high-level positions within their companies and organizations, with titles AM Lead, AM Consultant, Innovation Director, CEO, Head of Product Development, Director of Manufacturing, etc. In conducting these interviews, ICTC's objective was to identify national trends in the AM industry related to the Canadian AM landscape, its advantages and challenges, opportunities and weaknesses, availability of talent and skills needed, and the impact of COVID-19. The KIIs were identified mostly through LinkedIn, based on current job title and their company or organization's position in the AM industry. A diversity of participants and companies were chosen to ensure a broad range of perspectives and input for the report.

ICTC held three advisory committee meetings in tandem with the interviews to discuss and validate research findings and to receive feedback from industry and academia.

Advisory Committee

A project advisory committee was developed to guide this study and validate results. The advisory committee was comprised of 25 members from industry, industry associations, government, and academia. The committee met three times throughout the course of this study to assess findings, provide feedback and general research guidance. The committee was also leveraged for validation of in-demand AM jobs and skills.

Company Data Web Scraping

ICTC's data team used web scraping to gather data from leading job boards and websites of employers in order to extract data on in-demand jobs and skills required. Machine learning was utilized to collect job titles posted by a company, date the job was posted, location and company name. Duplicated jobs across the job boards were identified, removed and the data was aggregated accordingly. Web scraping was also used to extract valuable information on talent supply composition.

II Limitations of Research

Although efforts were made mitigate potential biases, considerable constraints were posed regarding the number of possible interviews and the availability of data availability. Some inaccuracies may thus have been overlooked.

Key Informant Interviews

As discussed, ICTC conducted 26 interviews with individuals from companies across Canada, a sample pool that is too small to be considered representative of the entire AM industry.

Web Scraping

ICTC made a significant effort to collect Canadian data on job postings and skills required. However, due to several reasons including current economic situation, Canadian labour market data was very limited, for this reason US data was collected and analyzed. As a result, the list of most in-demand AM roles and the list of key AM skills presented in the report were sources from the leading US job boards.

Data

There is a lack of data available for Canada's AM market, and much of the data that does exist is vague and inaccurate or provided in aggregate with data from the US. While this is changing as industry and organizations are starting to publish data and comprehensive reports, the current data gap should be considered a limitation of this report.

III Other Organizations Involved in AM in Canada

Research Centres

Canada is home to several well-known AM research centres funded by academia and government. As of 2020, almost every post-secondary institution has an innovation centre or specifically an AM research centre established at their facilities. They are typically research-focused with a degree of connection to the industry. Below are some examples of such AM research centres.

The **NSERC Network for Holistic Innovation in Additive Manufacturing (NSERC HI-AM Network)** aims to create collaborative interactions between partners and academic researchers to develop and commercialize novel materials, processes, control systems, and products for metal AM. NSERC HI-AM Network has been formed to address the challenges that prevent the industrial adoption of metal AM, and to equip Canada for the era of Industry 4.0.³²⁸ The HI-AM Network brings together 19 leading AM experts from seven Canadian universities, and is hosted by the University of Waterloo.

Some government funded institutions offer a range of services, including AM R&D. For example, **Conseil de recherche industrielle du Québec (CRIQ)** (a part of Investissement Quebec as of June 2020) supports companies in transition to innovative manufacturing.³²⁹ CRIQ offers specialized services for innovative companies: R&D (automation of manufacturing processes, environmental technologies, development of industrial equipment); product qualification tests and certification; industrial and technological information; standardization, certification and registration of ISO systems.³³⁰ As another example, the Centre de métallurgie du Québec (CMQ) supports companies working in metal AM through R&D activities, technical assistance and specialized training.³³¹

The **Multi-Scale Additive Manufacturing (MSAM)** lab is one of the largest AM facilities in the world focused on R&D. Hosted at the University of Waterloo, MSAM focuses on next generation AM processes. The lab explores novel techniques to develop advanced materials, innovative products, modelling and simulation tools, monitoring devices, closed-loop control systems, quality assurance algorithms, and holistic in-situ and ex-situ characterization techniques.

The **Marine Additive Manufacturing Centre of Excellence (MAMCE)** launched in 2017 and is the first in Canada to use 3D metal printing to manufacture certified parts for the marine industry. MAMCE focuses its research on enhanced corrosion protection, hybrid printing, smart parts, and blast resistance. The centre develops methods, procedures, and effective workforce training systems³³² and is funded by industrial, federal, and provincial organizations.

The **Additive Manufacturing Innovation Centre (AMIC)** at Mohawk College provides designers and manufacturers with a collaborative applied research environment for exploring AM technology on an industrial scale. The Centre's focus is on supporting industrial adoption of advanced manufacturing and industry 4.0 technologies for increased efficiency and better product design.³³³

The **Additive Design in Surgical Solutions (ADEISS)** Centre was established in 2017 as a result of partnership between with Western University, Renishaw PLC, and the London Medical Network.³³⁴ The centre focuses on the AM research, design, development and commercialization of alloy-based implants, medical devices and surgical instruments for use in the orthopaedic, dental, and veterinary markets.³³⁵

³²⁸ "About the NSERC HI-AM Network," NSERC NI-AM, 2020. <https://nserc-hi-am.ca/about-us/>

³²⁹ "Support for product development | Support for enhanced productivity – CRIQ," Investissement Québec-CRIQ, 2020. <https://www.criq.qc.ca/en/>

³³⁰ "Centre de recherche industrielle du Québec," Quebec Metro High Tech Park, 2020. <http://www.parctechno.com/en/registre/?id=27>

³³¹ "Mission, Vision, and Values," Centre de métallurgie de Québec, 2020. <http://cmqtr.qc.ca/en/mission-vision-and-values/>

³³² "About Marine Additive Manufacturing Centre of Excellence," MAMCE, 2020. <https://www.unb.ca/mamce/about.html>

³³³ "Additive Manufacturing Innovation Centre (AMIC)," Mohawk College, 2020. <https://www.mohawkcollege.ca/ideaworks/additive-manufacturing-innovation-centre-amic>

³³⁴ "Renishaw contributes to pioneering Canadian medical design centre," Renishaw, June 2017. <https://www.renishaw.com/en/renishaw-contributes-to-pioneering-canadian-medical-design-centre--42106>

³³⁵ "About the ADEISS," ADEISS, 2020. <https://adeiss.ca/about/>

The **Advanced Materials and Manufacturing (AMM) Institute** at the University of British Columbia is a research excellence centre with a mission of “keeping Canada at the forefront of advanced manufacturing industries.” It has partnerships with 160 companies in sectors—ranging from clean energy to primary metals—and works with three-quarters of the world’s top 20 aerospace companies. AM is one of the seven areas of focus at the Institute.³³⁶

The **Centre for Advanced Manufacturing and Design Technologies (CAMDT)** at Sheridan College seeks to provide a hub connecting industry, curriculum, and applied research. The Centre links companies of all sizes to Sheridan’s advanced manufacturing expertise and equipment, as well as Sheridan faculty and students. Additive Manufacturing is one of the key research areas at the Centre, which provides expertise and resources for scanning, prototyping, printing, and finishing for metal and plastic AM, as well as design (DfAM) services.³³⁷

Industry Bodies and Associations

Multiple AM hubs of various sizes exist across Canada. The two largest hubs are located in the Greater Toronto Area and in Montreal. There are smaller AM hubs in the cities of Vancouver, Saskatoon, Edmonton, and Winnipeg.

A range of industry bodies are focused on the promotion and development of AM in Canada.

- ▶ **Canada Makes** is a network of private, public, academic, and non-profit entities dedicated to promoting the adoption and development of advanced manufacturing and AM in Canada. The network covers a broad range of AM technologies, including 3D printing, reverse engineering 3D imaging, medical implants and the replacement of human tissue, metallic 3D printing, and more.³³⁸
- ▶ **Next Generation Supercluster (nGen)** is a not-for-profit organization funded by the Government of Canada. nGen aims to strengthen the competitiveness of Canada’s manufacturing sector, drive more innovation and investment in advanced manufacturing technologies in Canada, generate new commercial opportunities for Canadian companies in global markets, grow more large-scale world-leading Canadian enterprises, and develop a modern and inclusive workforce with the skills required to excel in advanced manufacturing today and in the future.³³⁹
- ▶ **Advanced Manufacturing Consortium (AMC)** aims to accelerate advanced technology adoption and unique solutions for manufacturing challenges by helping industry understand, assess, de-risk, and deploy advanced manufacturing technologies for business growth.³⁴⁰
- ▶ **Excellence in Manufacturing Consortium (EMC)** is a not-for-profit organization and Canada’s largest manufacturing consortium. EMC is dedicated to helping manufacturers grow and become more competitive.³⁴¹

³³⁶ “What we Do,” AMM, 2020. <http://www.amminstitute.ca/>

³³⁷ “Centre for Advanced Manufacturing and Design Technologies (CAMDT),” Sheridan College, 2020. <https://www.sheridancollege.ca/research/active-research/camdt>

³³⁸ “About Canada Makes,” Canada Makes, 2020. <http://canadamakes.ca/about/>

³³⁹ Next Generation Manufacturing Canada, 2020. <https://www.ngen.ca/>

³⁴⁰ “About Us,” Ontario Advanced Manufacturing Consortium, 2020. <https://www.amconsortiumontario.ca/about/>

³⁴¹ “About,” Excellence in Manufacturing Consortium, 2020. <https://www.emccanada.org/about>